

AT-FS2

Flight Simulator II



**Pilot's
Operating Handbook
and
Airplane Flight Manual**

**AT-FS2
FLIGHT SIMULATOR II**

Pilot's
Operating Handbook
and
Airplane Flight Manual

www.atari.com

© Bruce A. Artwick 1984

First Edition
First Printing
All Rights Reserved
SubLOGIC Corporation
713 Edgebrook Drive
Champaign Illinois 61820

Table of Contents

Introduction	7
Flight Training and Training Aids	9
Running the Program	10
System Requirements	10
Joystick Setup	10
Booting Up the Disk	10
Scenery Disks	11
Preliminary Adjustments	11
A Quick Test Flight	11
Flight Instrumentation, Radios, and Visual Systems	13
The Three-Dimensional Out-the-Window Display	13
The Standardized Instrument Cluster	13
Other Instruments	18
Engine Monitoring Instruments	19
Radios	19
Aircraft Controls	21
Primary Flight Controls	21
Control Yoke	21
Joystick Control	26
Rudder Pedals	26
Throttle Lever	28
Secondary Aircraft Controls	29
Flaps	29
Elevator Trim	32
Brakes	32
Engine Controls	32
Radio Controls	34
View Selector	35
Radar Selector	35
Miscellaneous Controls	36
Keyboard Techniques	36
Simultaneous Keypresses	36

Table of Contents

Flying the Aircraft	37
Flight under VFR Conditions	37
Getting Familiar with the Aircraft	37
Taxiing	38
Pre-takeoff Check	39
Takeoff	39
Climbing	40
Straight and Level, Constant Altitude Flight	40
Glides and Descents	41
Turns	41
Landing	42
Aircraft Refueling and Servicing	43
Custom Simulator Modes	44
The Editor	44
Entering the Editor	44
Using the Edit Arrow	44
Exiting the Editor	44
Current Flight Parameters	44
Simulation Control	45
Aircraft Position	46
Environmental Control	47
User Mode Library	48
Copying Modes	50
Saving and Loading The Mode Library to Disk	51
Editor Key Summary	53
The "World" and World Navigation	54
World Specifications	54
Getting Around in the World	54
Navigational Aids	56
VOR Navigation	56
Distance Measuring Equipment (DME) Navigation	64
Automatic Direction Finder (ADF) Navigation	64
Airport Beacons	64
Course Plotting System	66
Environmental Factors	68
Season and Time of Day	68
Weather – Clouds, Winds, and Turbulence	69

Table of Contents

Advanced Flight Techniques	70
Maneuvers and Advanced Maneuvers	70
Uncoordinated Flight	71
Instrument Flight	73
Playing "World War I Ace"	75
Starting the Game	75
Goal	75
Fighting the Fighters	76
Fighter Mode Instrumentation	77
Using Radar	77
Bombing	78
Getting Shot Down	78
Becoming an Ace	78
Appendix 1. Aircraft Specifications	79
Appendix 2. Aircraft Characteristics	81
Appendix 3. 48K and 64K Feature Comparison	83
Appendix 4. Program Specifications	84
Appendix 5. Interesting Topographical Features	86
Index	87

Introduction

Welcome to the AT-FS2 microcomputer-based flight simulator. This simulator runs on the Atari 400, 600, 800, 1200, and 1400 series computers with 48K minimum RAM and single floppy disk drive. It offers aircraft flight simulation that considers 47 important aircraft characteristics and provides an out-the-window view using a 3D dynamic shaded color graphics flight display. Extensive flight controls (accessible using keyboard or joystick) and minimum VFR and IFR instrumentation as specified by the FAA (displayed on the screen) are included.

The AT-FS2 simulates the instruments and flight characteristics of a Piper PA-28-181 Archer II; a single engine, 148 mph, non-retractable gear aircraft equipped with a good set of avionics. This aircraft was chosen because it offers good performance yet is simple (it has no retractable gear or constant speed prop) and is easy to fly.

In addition to flight simulation, AT-FS2 includes the "WW I Ace" game. This game equips the plane with bombs, machine-guns and a radar screen and provides an entertaining match of pilot skill and strategy against computer controlled enemy aircraft.

This is a SubLOGIC second-generation flight simulator. The flickering black and white line-drawing graphics of first-generation simulators are replaced by solid, shaded color graphics. Flight instruments now look like "the real thing" rather than simply being adequate. The flying environment also is improved. The small "world" of a few hundred square miles is replaced by a world that is more than ten-thousand by ten-thousand miles square and encompasses the whole continental United States with a resolution finer than 2.5 inches. Flight Simulator II now includes more than eighty airports, winds, clouds, time of day (for day, dusk, and night flight), and navigation aids.

The added features make the aircraft much more difficult to fly than first-generation simulators, so as a convenience to new pilots, two flight modes are provided. The *easy* mode makes the aircraft very forgiving of flight control, engine control, and navigation blunders. The *reality* mode adds more sophisticated flight simulation factors.

The simulator will now be described. A few essentials will be covered in the **Quick Test Flight** section so you can get the program running and the plane off the ground. Controls, instruments, flight techniques and navigation then will be covered in detail.

Flight Training and Training Aids

The FS2 is useful in many flight training areas (navigation, visual orientation, and illustration of flight fundamentals). Although the simulator is entertaining and flies surprisingly like a real airplane, there is no substitute for a good flight training course that includes ground school and flight time in real aircraft.

The regulations regarding the logging of simulated instrument approaches (for general aviation under FAA Regulations Part 61.57) are hazy.

SubLOGIC is pursuing the topic of acceptance and approval by the FAA (perhaps with the addition of flight control hardware).

This manual explains flight simulator behavior and basic flying techniques. It is not a thorough flight instruction course. Further training handbooks and maps will be very helpful, especially for the novice pilot. Flight manuals and maps are available at FBOs (Fixed Base Operators) or flight training schools at most airports. They may also be obtained directly from mail-order suppliers such as Sporty's Pilot Shop, Clermont County Airport, Batavia, Ohio 45103, (513) 732-2411. The following publications are recommended:

For the novice pilot with no manuals yet:

Flight Training Handbook. 1980 revision. U.S. Department of Transportation, Federal Aviation Administration.

Aviation Fundamentals. 6th Edition. Jeppesen Sanderson, Inc.

Instrument Flying Handbook. 1980 revision. U.S. Department of Transportation, Federal Aviation Administration.

For all pilots:

Airman's Information Manual. Latest edition. Aero Publishers Inc.

Seattle Sectional Aeronautical Chart

Los Angeles Sectional Aeronautical Chart

New York Sectional Aeronautical Chart

Chicago Sectional Aeronautical Chart

Running the Program

Before delving into aircraft controls and instrumentation, it's a good idea to get the simulator running. The startup procedures now will be covered.

System Requirements

The following equipment is required:

1. Atari computer.
2. At least 48K of RAM.
3. At least one floppy disk drive.

The following equipment is optional:

4. One or two joysticks.

NOTE: A few features are available only with 64K of RAM installed. These features are switched in automatically. See Appendix 3 for a 48K and 64K feature comparison.

Joystick Setup

A joystick can be used for aileron, elevator, brakes, and machine gun control. A second joystick can be used for throttle and flaps control.

Plug the left joystick into *controller jack 1* and the right joystick (if used) into *controller jack 2*. The section on **Joystick Control** explains the joystick's function. If you are just getting started with the simulator, use keyboard controls until you get familiarized. All examples use keyboard entry, and a joystick will just confuse matters.

Booting up the Disk

Turn off the Atari computer, and turn on the disk drive. Insert the disk labeled **Flight Simulator II**. Turn on the computer. The control panel and program will then load. Load time is about one minute.



A menu will appear. Select your monitor type. Then select Demo or Flight mode.

Scenery Disks

The **Flight Simulator II** disk contains scenery for the Chicago and War Game scenery areas. Typing CTRL E while in flight mode lists the available scenery areas on the disk currently in the drive.

Disks marked **Scenery Disk** are used to store scenery in other areas. A scenery disk for the Chicago, Los Angeles, New York, and Seattle areas is included with this package. Scenery disks for other areas can be obtained from SubLOGIC.

To use a scenery disk, run the flight simulator and get into flight mode. Remove the **Flight Simulator II** disk and insert the **Scenery Disk**. Type CTRL E to 'log in' the scenery disk and display the available scenery areas.

NOTE: Always make sure to type CTRL E after inserting a scenery disk. This informs the computer that more scenery is available on the newly inserted disk. The  and  keys also function as a CTRL E keypress.

Preliminary Adjustments

The FS2 flight simulator is at its best when displayed on a color television or a composite color monitor. Black and white TVs or monitors can also be used. A startup menu will ask you to specify your monitor type (color or black and white). Scenery colors will be modified to best suit your monitor type.

A Quick Test Flight

The following steps are presented to get you flying as quickly as possible. This procedure gives an idea of what the simulator is all about and satisfies the natural urge to take the plane out for its first flight without reading the airplane flight manual first.

1. Boot the disk labeled **Flight Simulator II** as described in the **Booting up the Disk** section.
2. When the instrument panel and startup menu appears, press the A key if you have a color monitor or B for a black and white (or monochrome) monitor.
3. On the second startup menu page, press A for an automatic demo (reboot to get out of it) or press B to continue the test flight.

4. You are now on the runway at Meigs Field in Chicago (a small airport on a peninsula, surrounded by Lake Michigan). Press 5 followed by F. This is a view out the left side of the airplane. Notice the wing at the bottom of the 3D view on the screen.
5. Press 5 followed by B. This is a view out the back of the plane. Notice the tail at the screen's center.
6. Press 5 followed by T. This reverts to forward view.
7. Press B three times in rapid succession (no more than 1/2 second between keypresses). This raises the elevator a bit.
8. Press the RIGHT ARROW key sixteen times in rapid succession. This increases throttle to full. The plane will start rolling down the runway.
9. The plane will take off by itself. It will be visually obvious when you leave the ground. Once off the ground, press 5, then B to look out the back again. Press 5, then T for front view. Watch the flight instruments. Airspeed, altimeter and vertical velocity gauges will all show movement.
10. Press F. The plane will start banking. You will notice the horizon "tilting." Don't let the bank get too steep. After about 20 degrees of bank, press G to neutralize the ailerons and keep the plane in its current bank.
11. Press ESC. A large menu will appear. This menu is used to adjust flight parameters. Hit the RETURN key many times. The arrow will sequence through two edit pages with about forty adjustable parameters. After looking them over press ESC again to get back into flight mode.
12. Now press H five times and wait for about one minute without interfering with the controls.
13. After a crash, the simulator resets and returns you to the programmable starting location.

Flight Instrumentation, Radios, and Visual Systems

The FS2 has all instruments and equipment required under FAA regulations parts 91.33, 91.24, and 91.52 for day and night visual flight rules (VFR) and day and night instrument flight rules (IFR) under non-icing conditions, including flight within terminal control areas. A digital clock with an *hours, minutes, seconds* readout now is accepted in place of a sweep second hand for instrument flight and is used in the FS2. Figure 1 defines the simulator's 3D display, flight instruments and radios. The display screen is split horizontally into two sections: the upper 3D out-the-windshield display, and the lower half instrument panel and radio stack.

The Three-Dimensional Out-the-Window Display

This is a view out the aircraft's forward windshield. Ground terrain, runways, and the horizon are usually visible. In extreme cases (such as when performing aerobatics) only the sky or ground is visible.

Visual effects are very similar to those encountered in real flying. Going through clouds causes the view to become completely white. On clear days, the sky is blue. Cloudy days result in a gray sky unless you break through the cloud layer to blue sky.

The default viewing direction is out the front windshield. You may also look at the world from nine different viewing angles (including left, right, and down) using the *view selector feature* (see the **Aircraft Controls** section for details).

The Standardized Instrument Cluster

The six basic flight instruments are grouped in the standardized instrument cluster shown in Fig. 1. This cluster includes:

Item	Function
1	Airspeed indicator (indicates airspeed in knots).
2,3	Attitude indicator or artificial horizon.
4,5	Altimeter (altitude in feet above sea level, not above ground level).
47,48	Turn coordinator.
44,45,46	Heading indicator (directional gyro or gyro-compass).
40	Vertical speed indicator or rate of climb indicator (reads in hundreds of feet per minute).

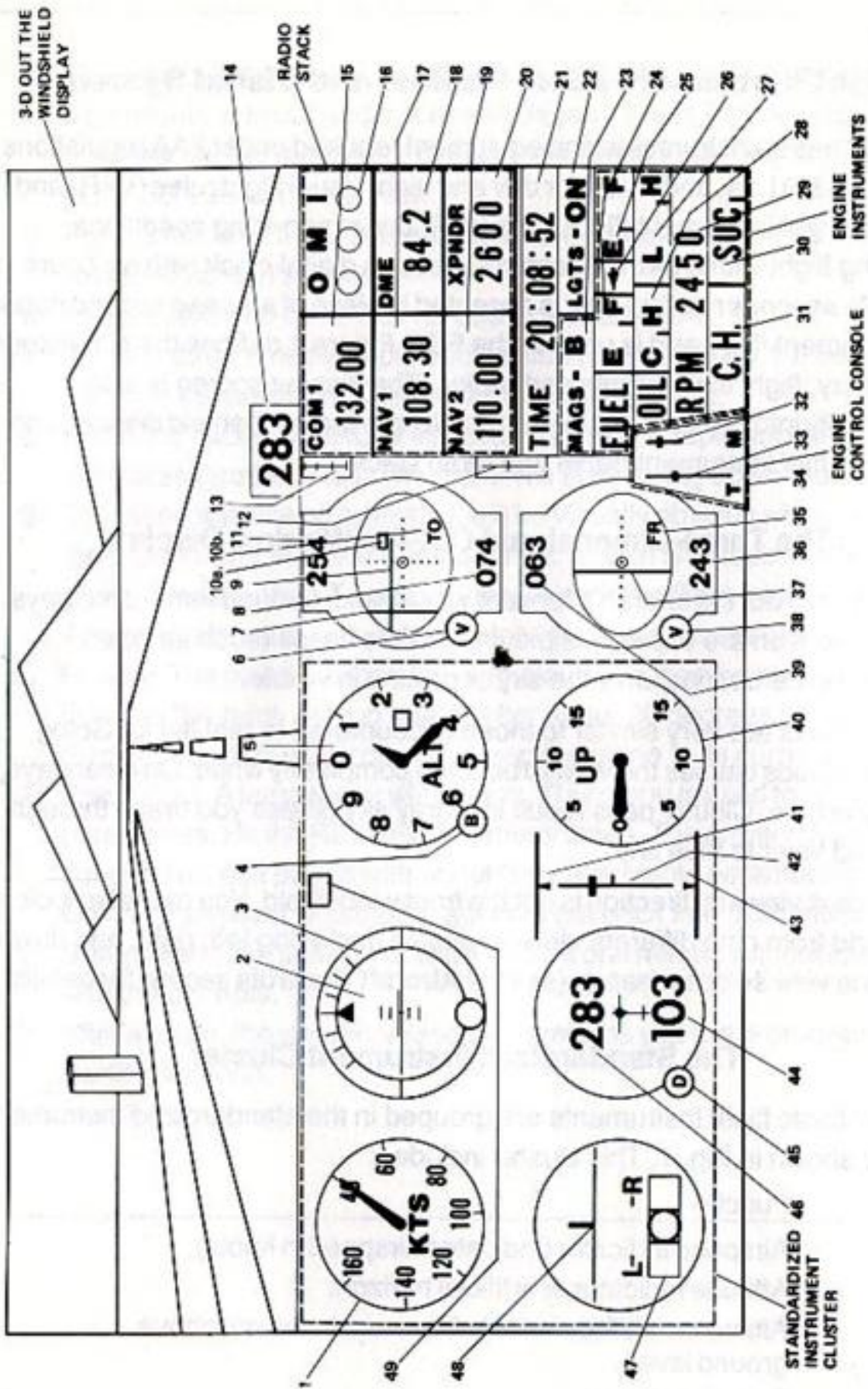

Figure 1. Display Screen

1. Airspeed indicator (speed in knots)
 2. Attitude indicator (artificial horizon)
 3. Bank indicator
 4. Altitude set knob (barometric pressure adjustment for the altimeter)
 5. Altimeter
- VOR 1
6. Omni-bearing selector knob
 7. Course deviation indicator needle
 8. Reciprocal course selector
 9. Glideslope needle
 - 10a. Glideslope flag
 - 10b. TO-FROM-OFF flag
 11. Course selector
 12. Elevator trim tab position indicator
 13. Flaps-position indicator
 14. Magnetic compass
 15. COM (communications) radio
 16. Outer, middle, and inner marker beacon indicator lights
 17. NAV (navigation) radio one
 18. Distance measuring equipment readout (nautical miles)
 19. NAV radio two
 20. Transponder
 21. Clock
 22. Lights on/off indicator
 23. Magneto switch position indicator
 24. Left tank fuel gauge
 25. Right tank fuel gauge

26. Fuel gauge selector arrow (points at tank in use)
27. Oil pressure gauge
28. Oil temperature gauge
29. Digital tachometer
30. Suction gauge
31. Carb heat indicator. C.H. is off, HEAT is on.
32. Mixture control indicator
33. Throttle control indicator
34. Engine control console

VOR 2

35. TO-FROM-OFF flag
 36. Reciprocal course selector
 37. Course deviation indicator needle
 38. Omni-bearing selector knob
 39. Course selector
 40. Vertical speed indicator
 41. Aileron control position indicator
 42. Elevator control position indicator
 43. Rudder control position indicator
- Heading Indicator
44. Reciprocal heading indicator
 45. Trim knob (used to adjust gyro heading to magnetic heading)
 46. Heading indicator
- Turn Coordinator
47. Slip indicator (ball)
 48. Turn coordinator
 49. Stall warning light

These instruments are arranged as they would be in nearly any aircraft. The style of these instruments varies from plane to plane. The most modern forms of these instruments are used in this simulator.

Airspeed Indicator (item 1)

This instrument measures airspeed in knots. This is an air-pressure activated gauge and indicates the speed the aircraft is moving through the air around it. This gauge does not show ground speed.

Attitude Indicator or Artificial Horizon (items 2,3)

The words *artificial horizon* summarize this instrument's function. Markings on the instrument's face aid you in determining the aircraft's pitch and bank attitudes. The center bar, when aligned with the horizon, indicates straight and level flight. Bank markings at the edge of the instrument (item 3) indicate 10, 20, 30 and 60-degree banks. The *bank indicator* (a small arrow at the top of the gauge) points to the bank markings. The arrow is stationary at the top of the gauge – the markings around the edge move. Horizontal markings near the center indicate nose-up and nose-down pitch angles.

Altimeter (items 4,5)

Altitude in feet above sea level is measured. This gauge is read as a clock face with 10 instead of 12 divisions. The small hand indicates thousands of feet, while the large hand indicates hundreds. The FS2 altimeter has fine 20-foot increments between the 100-foot markings. Atmospheric pressure operates this gauge. Barometric pressure changes caused by changes in the weather can cause errors in the altitude reading, so pilots flying below 18,000 feet must often calibrate this gauge to the barometric pressure of the airspace through which they are flying. The small knob on the gauge (item 4) is used to set the barometric pressure in the small square window on the face of the altimeter (near the "3"). The FS2's altimeter can be adjusted for barometric pressure by pressing the CTRL B key. A "B" appears on the altimeter's adjustment knob to reference this key.

A small arrow near the outside of the gauge (64K) acts as the gauge's "third hand" which indicates tens of thousands of feet. Remember, this gauge reads altitude above sea level, not ground level. At an airport at a 750 ft. elevation, the altimeter reads 750 ft. while sitting on the ground (after barometric pressure adjustment).

Turn Coordinator (items 47,48)

The airplane silhouette (item 48) indicates rate of turn. No numerical value is presented on this gauge. Instead, a single turn rate position is marked. When the gauge aligns with the L or R, a 2-minute turn results (a turn rate of 180 degrees per minute). The turn coordinator, unlike the turn indicator gauge used in some planes, uses a 35-degree canted gyroscope that reflects both bank and heading changes. Pitch, however, has no effect on this gauge.

The ball portion of the turn indicator (item 47) is a *slip/skid* indicator that indicates the degree of aircraft coordination. When the ball is centered, the aircraft's longitudinal axis is parallel to the direction of flight and the flight is *coordinated*. Coordinated turns are the safest turns and require appropriate amounts of bank and yaw using ailerons and rudder. Some maneuvers (notably slips and skids) are not coordinated. These will be covered in the **Advanced Flight** section.

Heading Indicator or Directional Gyro (items 44,45,46)

This is basically a gyroscopically-controlled compass. This compass is much more responsive and steady than the magnetic compass (item 14) which tends to bob around unless the aircraft is flying smooth, straight, and is not accelerating or decelerating. The FS2's heading indicator shows both course (item 46) and reciprocal course (item 44). The heading indicator, being gyroscopically operated, has no inherent direction seeking characteristics and must be set manually using the magnetic compass before a flight. Gyroscopic procession and the earth's rotation cause the gyro-compass to drift over a short period of time, so the pilot should occasionally (at least a few times per hour) adjust the gyro-compass to match the magnetic compass. The knob on the gauge (item 45) is used for this adjustment.

The FS2's heading indicator can be set to the current magnetic compass heading by pressing the CTRL D key. A "D" is marked on the heading indicator's adjustment knob as a reference. Make sure the magnetic compass has settled down after a turn or airspeed change to avoid an erroneous heading setting.

Vertical Speed Indicator (item 40)

This instrument shows rate of climb or descent in hundreds of feet per minute. This gauge operates on air-pressure change and is not adversely affected by absolute barometric pressure. New pilots are cautioned not to "chase" this gauge in pursuit of constant-altitude flight. The gauge lags slightly behind the aircraft's responses and so will the pilot's responses if this gauge is chased.

Other Instruments**Magnetic Compass (item 14)**

This instrument appears at the top of the panel above the radios. This is a standard magnetic compass. It is assumed to be magnetically correct and requires no correction card to interpret. The compass is subject to isogonic effects (variations in *true* versus *magnetic* north).

Omni-Bearing Indicator with Glide Slope (items 6 to 11)

This is a navigation and landing approach instrument that is used in conjunction with the NAV radio and VOR stations. This instrument and its operation will be explained in the **World Navigation** section. A second omni-bearing indicator (items 35 to 39) with no glide slope is provided. Two NAV radios and omni-bearing indicators are useful in navigation and greatly simplify instrument flight.

Clock (item 21)

This is a standard digital clock that measures hours, minutes and seconds. This clock runs in real time. Under the 1982 Federal Aviation Regulations, a digital presentation qualifies for IFR flight in lieu of an analog sweep second hand clock.

Lights Indicator (item 22)

This indicator tells whether the aircraft's lights are on or off.

Magnetos Indicator (item 23)

This indicator shows the condition of the magneto switch (off, right, left, both, start).

Carb Heat Indicator (item 31)

This indicator indicates whether the carburetor heat is turned on or off. When off, the letters C.H. appear. When on, the word HEAT appears in orange letters.

O, M, and I Lights (item 16)

These indicators are the outer, middle, and inner marker lights that are used on instrument approaches.

Stall Warning Light (Item 49)

This light is activated when you drop to five knots above stall speed.

Engine Monitoring Instruments

These instruments include:

Item	Function
24	Left fuel tank gauge.
25	Fuel tank selector indicator (points to right or left fuel gauge to indicate current tank being used).
26	Right fuel tank gauge.
27	Oil pressure gauge (L and H stand for low and high).
28	Oil temperature gauge (C and H stand for cold and hot).
29	Digital tachometer indicates engine RPM.
30	Suction gauge indicates vacuum available to operate vacuum-driven gauges.

Radios

Six radios are provided: the NAV1 and NAV2 (navigation), COM (communication), DME (distance measuring equipment), ADF (automatic direction finder), and transponder (see Fig. 1).

The NAV radios (items 17 and 19) are used to tune-in and identify VOR navigation aids (to be covered later). These are 200-channel radios that receive frequencies between 108.00 and 117.95 MHz with 50 kHz separation. These receivers control the omni-bearing indicators (Fig. 1, items 6-11 and 35-39). The NAV1 radio controls the top omni-bearing indicator, and the NAV2 radio controls the bottom omni-bearing indicator.

The communication radio (item 15) is a 360-channel transceiver that covers frequencies between 118.00 and 135.95 MHz with 50 kHz separation. The flight simulator uses the COM radio as a receiver only. Airport, weather, and approach information can be received by tuning in Automatic Terminal Information Service (ATIS) which is available near major airports. The area maps give the ATIS frequencies for each airport where ATIS is available. The *common traffic advisory frequency* is listed for airports with no ATIS.

The DME radio (item 18) is tuned to the NAV1's VOR station. Its digits tell you how many nautical miles from the VOR station you are.

The ADF (64K ONLY) is used to tune non-directional radio beacons (NDBs). When the ADF option is selected using the editor, the bearing indicator (the gauge used with the ADF receiver) takes the place of VOR2, and the ADF receiver replaces the NAV2 radio. The ADF receiver covers the frequencies from 200 kHz to 999 kHz in 1 kHz increments.

Two additional radios are added for sake of completeness. An encoding altimeter is hidden behind the instrument panel (so ATC can check your altitude), and an emergency locator transmitter is mounted behind the back seats (so you can be rescued when you crash).

Aircraft Controls

The Atari machines are excellent computers, but their standard equipment unfortunately does not include a control yoke, rudder pedals, and a throttle lever. Keyboard keys therefore are used as aircraft controls. At first, this may seem like a poor way to control the aircraft – one that could not possibly give you the feel of the real controls. When properly arranged, however, keys give excellent controllability. The simulator also accepts joysticks which add to control realism.

The simulator, like a real aircraft, has many controls, but only the primary flight controls are needed to get you flying. The best way to learn the simulator's controls is to start with the primary flight controls. Other controls can be learned as needed after your first few flights.

Primary Flight Controls

Figure 2 shows the FS2 primary control keys. These keys are arranged positionally. Instead of using key letters for references (such as R for right and L for left), a *control diamond* pattern is used. The idea is to position your hand on the control diamond keys (middle finger on the G key, index on F, ring finger on H) and press the keys by rocking your hand right and left as you would a joystick.

Familiarize yourself with the definitions of yaw, pitch, and roll (see Fig. 2). Figure 2 also shows the primary flight controls and aircraft control surfaces (movable wing sections that cause the aircraft to yaw, pitch and roll about its axes). The control keys correspond to the physical positioning of the yoke and rudder pedals in an aircraft.

Keyboard keys don't give the position feedback that real controls do, so control position indicators are shown on the instrument panel (Fig. 1, items 33, 41, 42, 43).

Control Yoke (or Stick)

The control yoke is a steering-wheel-like control on some planes, and a control stick on others. Yoke rotation or stick right-left movement controls the ailerons and causes the aircraft to roll. Yoke movements toward and away from the pilot or stick forward and back movements control the elevator and cause the plane to pitch *nose-up* or *nose-down*.

1. Left and right flaps are linked to raise and lower together.
2. Left and right ailerons are linked to raise and lower in opposite directions from one another.

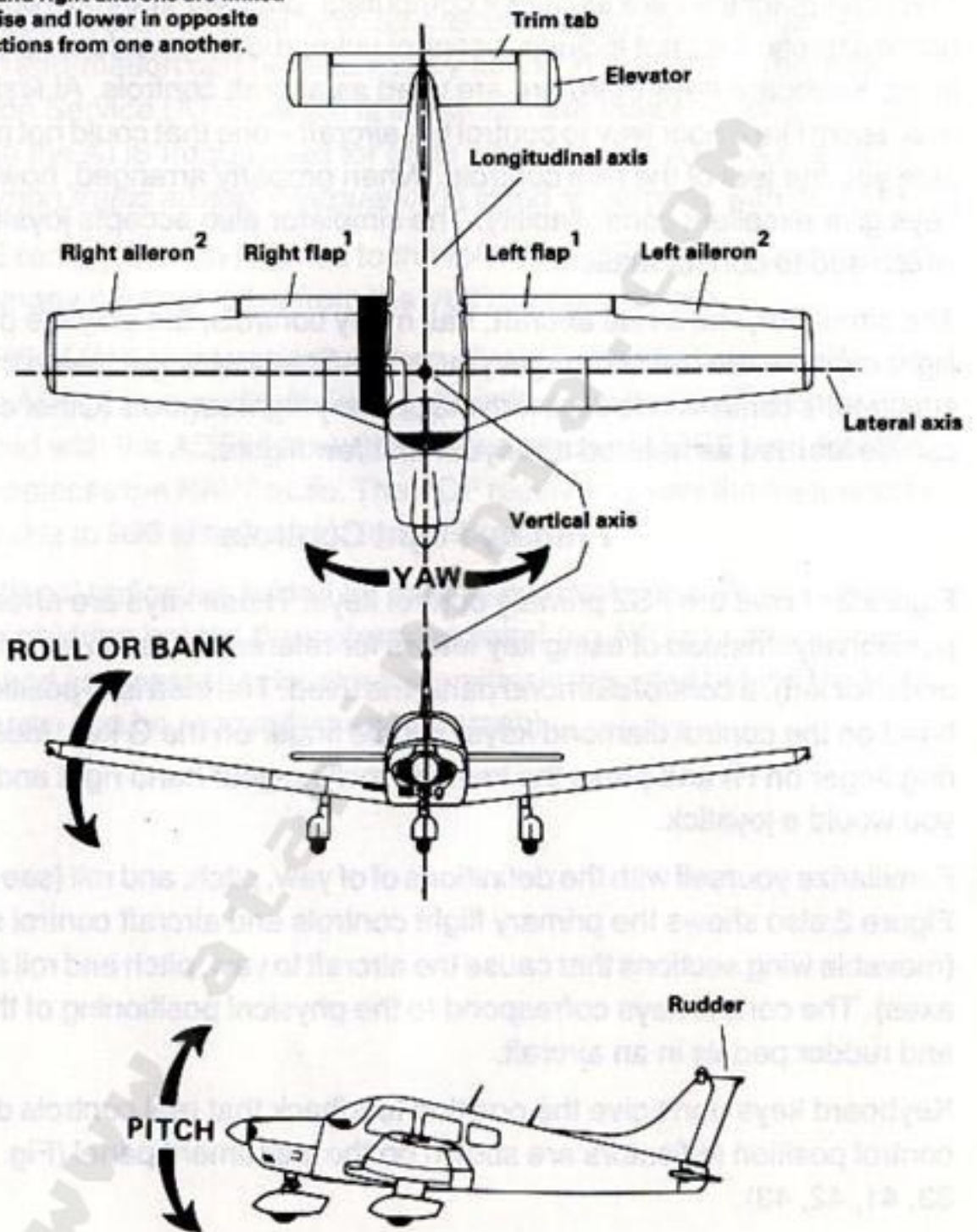

a) Control surfaces and rotational axes

Figure 2. Primary Flight Controls

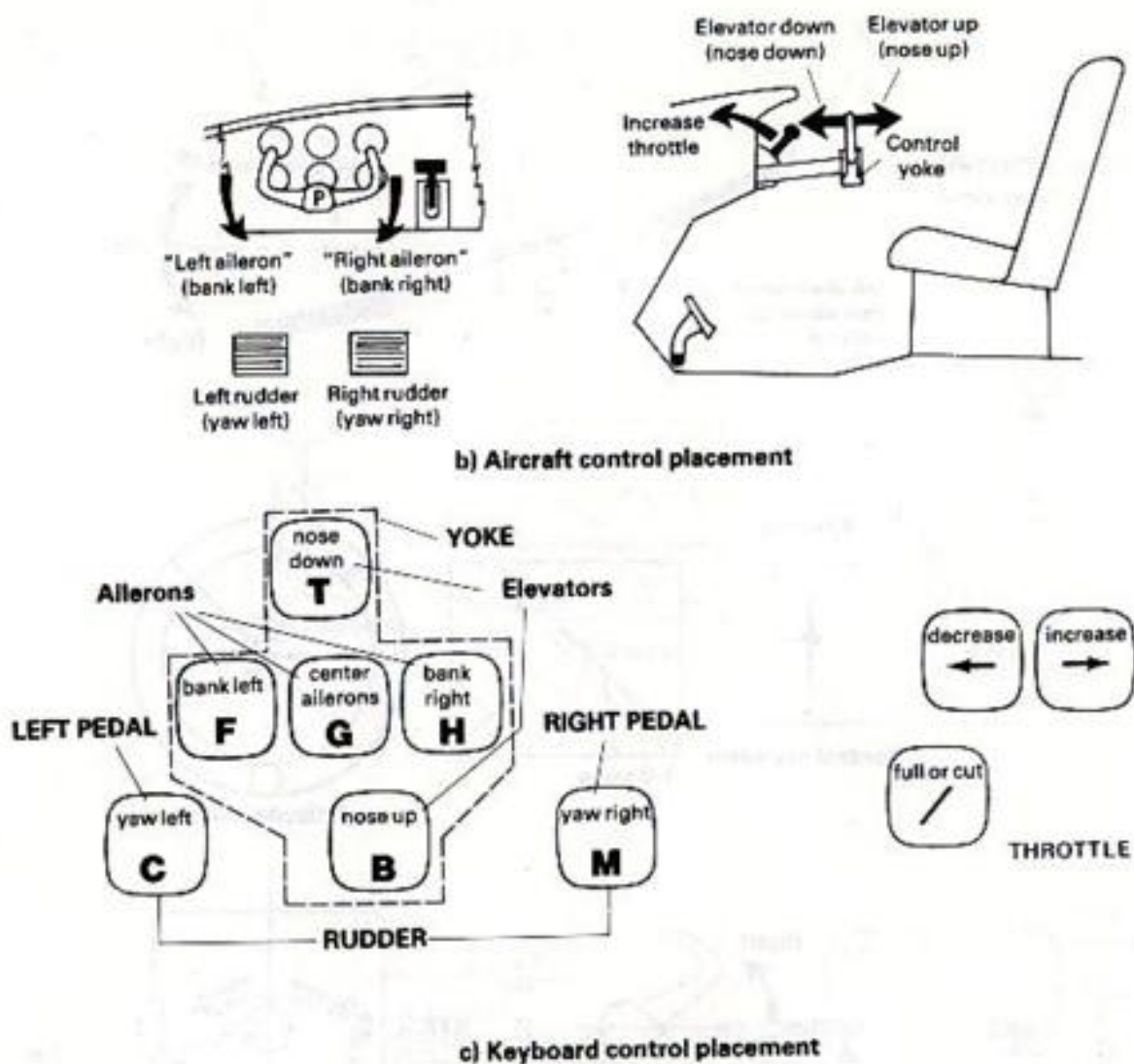

Figure 2. (continued)

Figure 3 shows the yoke's aileron control function and effects.

Figure 4 shows the yoke's elevator control function and effects.

Practice using the yoke:

1. Boot up the simulator.
2. Position your right hand on the control diamond (middle finger on G).
3. With your index finger, press the F key 3 times. Rock your hand about the G key as you would move a joystick to press F.
4. Notice the aileron control indicator (see Fig. 3) move to the left.
5. Press G to center the ailerons.
6. Try right ailerons (H) key, and move the aileron indicator right and left without using the center key. The center key is only a convenience to let you quickly move the ailerons to center position.

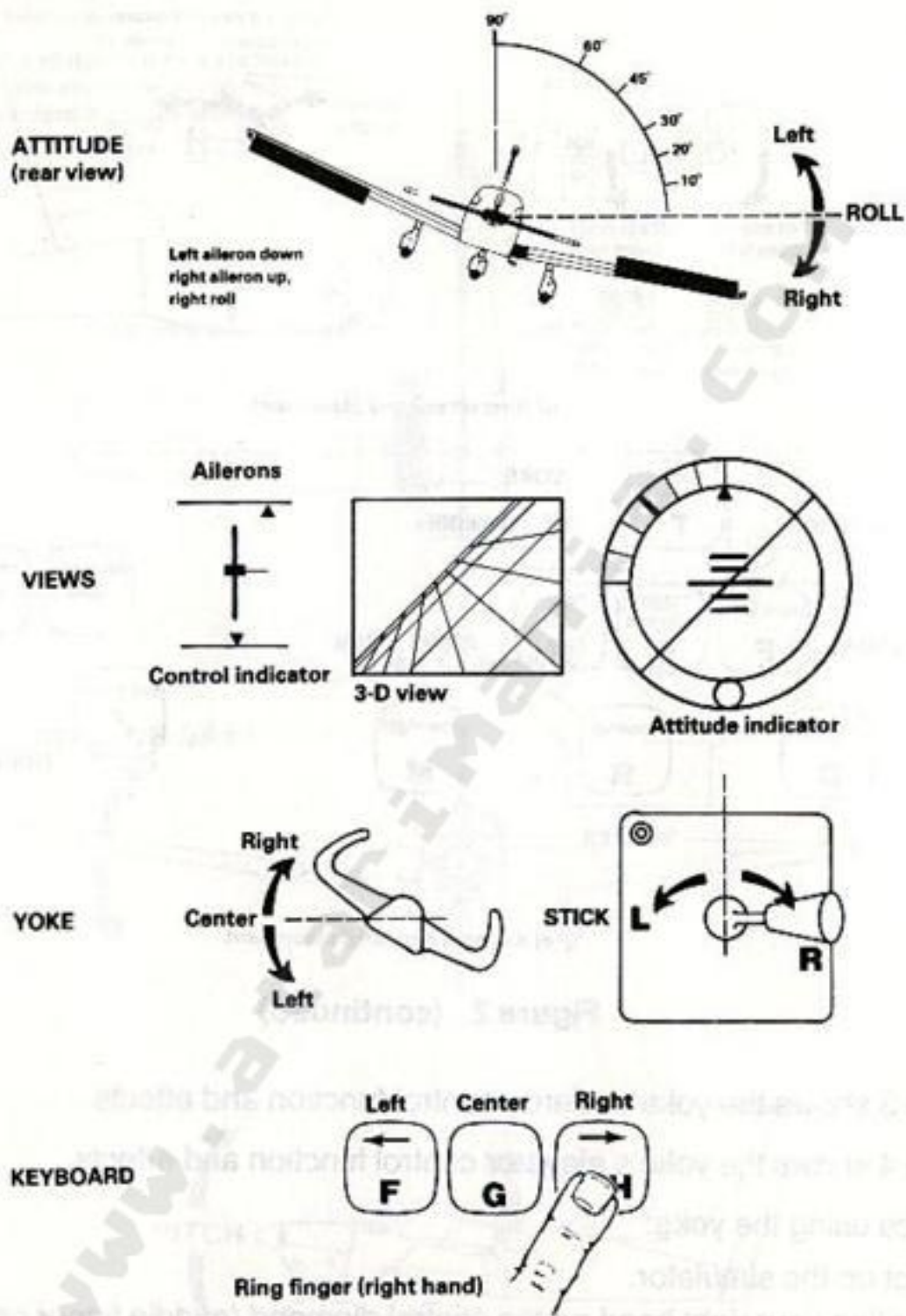

Figure 3. Ailerons – Controls and Effects

7. Move the elevator through its control range. Rock your hand forward and backward pressing the T and B keys quickly and repeatedly for nose-down and nose-up control. Think of this motion as pushing the yoke away from and toward yourself.
8. Watch the elevator control indicator on the panel (see Fig. 4).

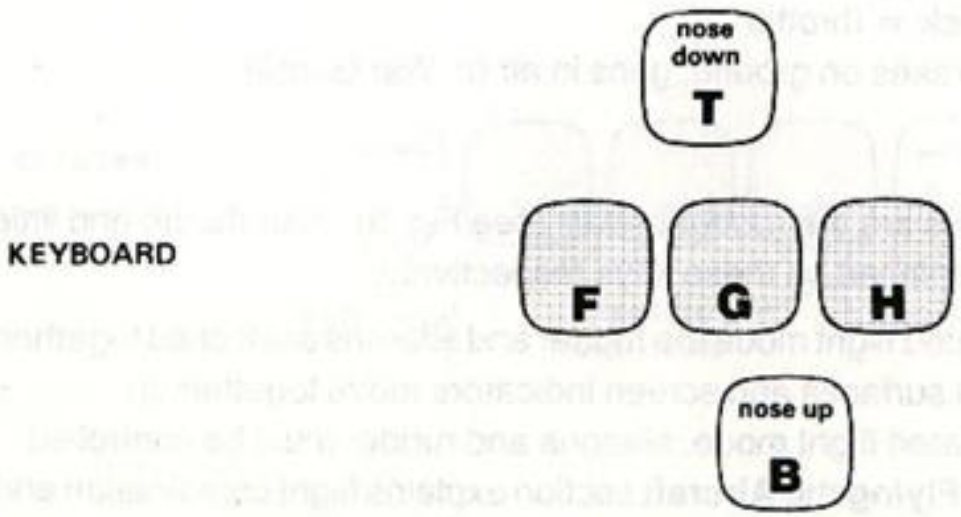
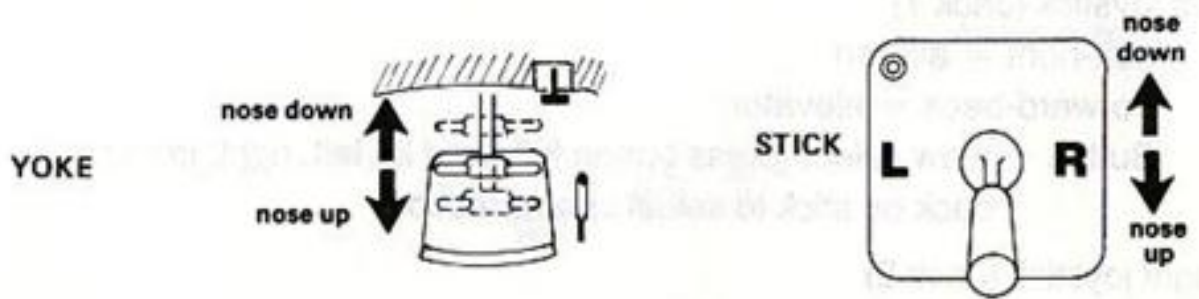
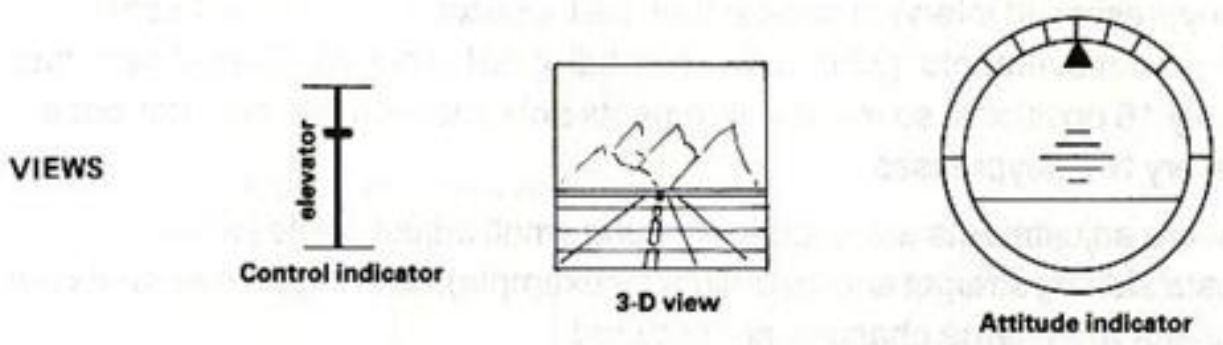
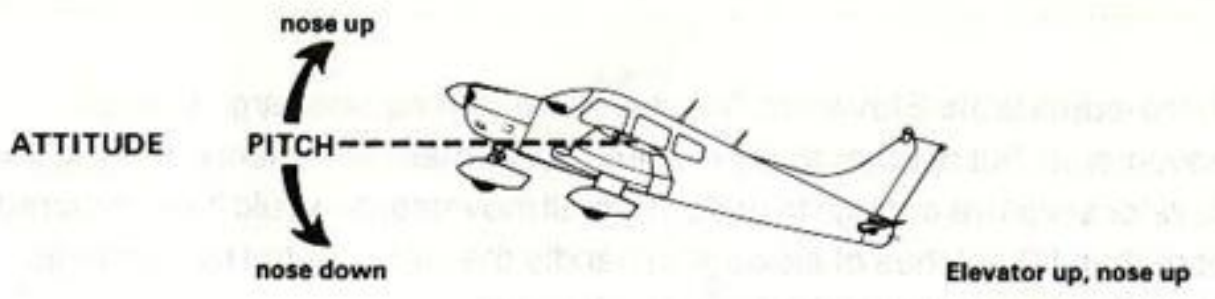

Figure 4. Elevator—Controls and Effects

Micro-adjustable Elevator: The elevator often requires large control movements, but at other times requires very small movements. Making the elevator sensitive enough to perform small movements would have required more than 50 notches of elevator to handle the large control movements. Instead, a "micro-adjustable" elevator is used.

Rapid elevator keypresses cause the elevator to move in large steps (about 16 notches from full up to full down). Single keypresses or sequences of keypresses at intervals greater than half a second result in half-scale "micro-movements" (32 notches from full up to full down). The indicator has only 16 positions, so micro-movements only show on the indicator once every two keypresses.

Micro adjustments are good for making small adjustments (when establishing straight and level flight for example), and large movements are useful when large changes are required.

Joystick Control

One or two joysticks can be used. They control the following:

Left joystick (Jack 1)

Left-right = aileron

Forward-back = elevator

Button = view select (press button followed by left, right, front or back on stick to select view direction)

Right joystick (Jack 2)

Left-right = flaps

Forward-back = throttle

Button = brakes on ground: guns in air (in War Game)

Rudder Pedals

The C and M keys are the *rudder pedals* (see Fig. 5). Your thumb and little finger should be placed on these keys respectively.

In auto-coordinated flight mode the rudder and ailerons are locked together and both control surfaces and screen indicators move together. In manual-coordinated flight mode, ailerons and rudder must be controlled separately. The **Flying the Aircraft** section explains flight coordination and when to use manual and auto-coordinated modes.

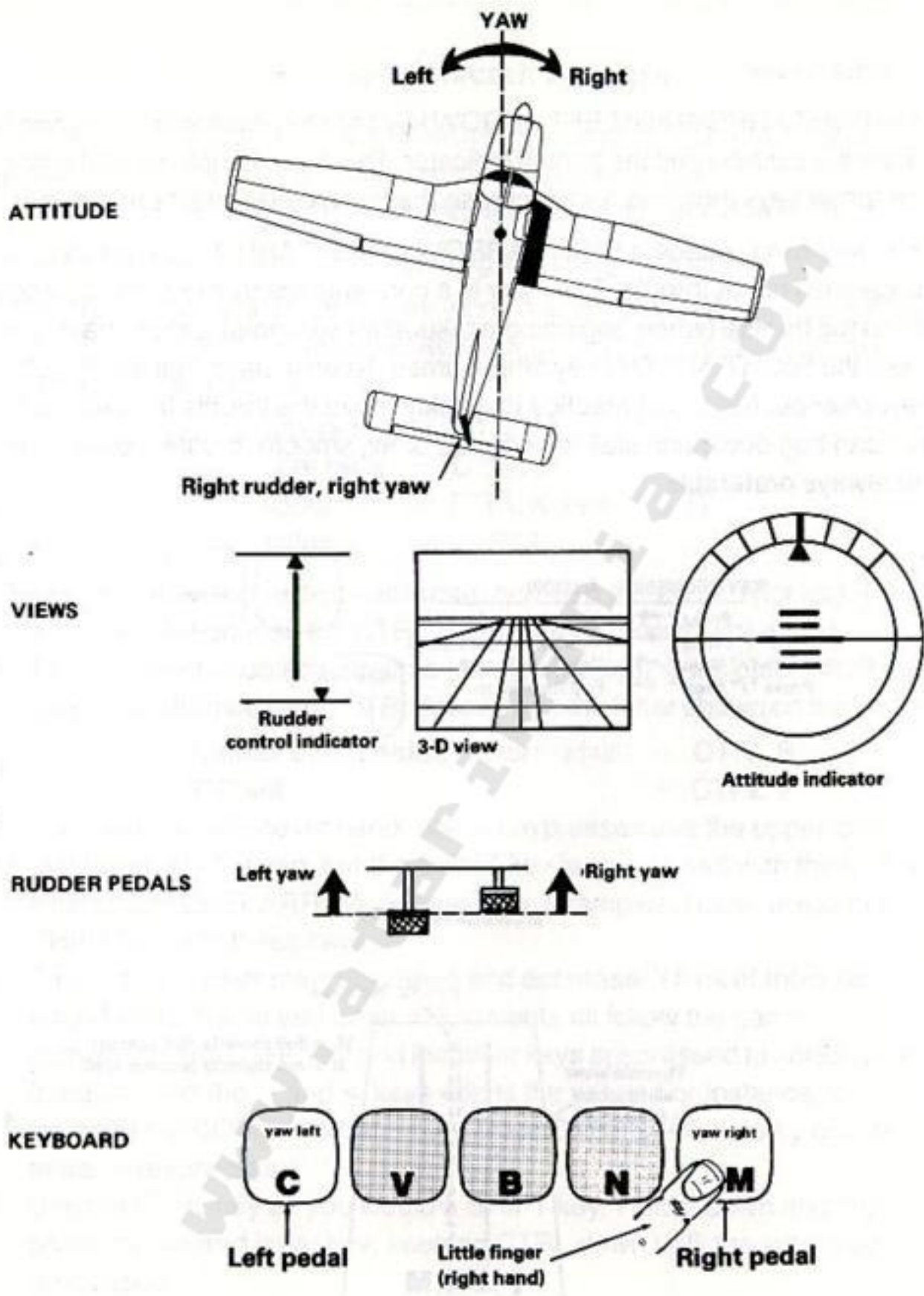

Figure 5. Rudder – Controls and Effects

Throttle Lever

The RIGHT ARROW and LEFT ARROW keys are the throttle lever. Figure 6 shows the controls and the throttle indicator. There are 15 notches of throttle. The arrow keys increase and decrease the throttle one notch per press.

The / key can precede a RIGHT ARROW or LEFT ARROW keypress to indicate full or cut throttle. The / key is a convenience that lets you go from idle to full throttle (when beginning a takeoff for example) without having to press the RIGHT ARROW key fifteen times. Keep in mind that this is just a convenience. It is a bad practice to quickly move the throttle from idle to full as it can bog down and stall the engine. Slow, smooth throttle movements are always preferable.

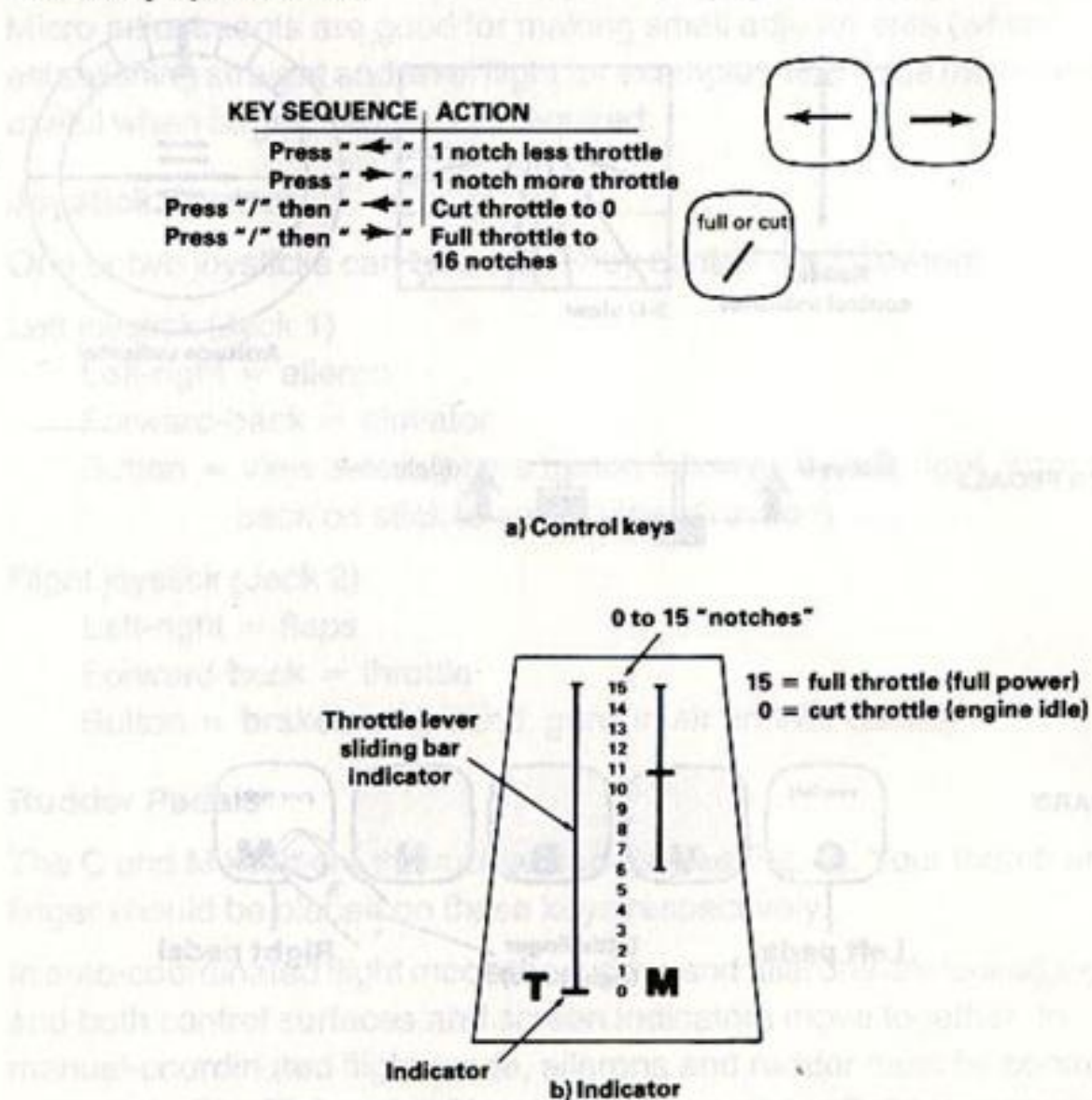

Figure 6. Throttle—Controls and Indicator

Secondary Aircraft Controls

Secondary aircraft controls adjust less-often-used control surfaces, set radios, control the engine, and control the simulation itself. The AT-FS2 Flight Reference Card (Fig. 7) outlines the complete control key set.

There are a few general rules regarding key assignments:

1. All right-panel adjustments (nav, com, mags, lights, etc.) are performed using the CONTROL or CTRL key with the first letter of the item to be adjusted. For example:

nav radio	=	CTRL N
com radio	=	CTRL C
xpndr	=	CTRL X (or CTRL T)
lights	=	CTRL L

The only exception to this rule is carb heat which is CTRL I (for ice). This was chosen because the CTRL H key is in the control yoke area.

2. All instrument knob adjustments (altimeter, heading indicator, VOR OBI set) are performed using CTRL followed by the letter shown on the knob:

altimeter barometric pressure adjust	=	CTRL B
VOR set	=	CTRL V

3. The SHIFT key is never used. Some keypresses use the upper case symbol on the keycap, but the SHIFT key is never used with them. The RIGHT and LEFT ARROW keys are two examples. Never press the SHIFT key with these keys.
4. The > and < keys mean increase and decrease. Think of them as arrowheads. Radio and other adjustments all follow the same convention: the CTRL key and identifier keys are pressed to select what to adjust, and the > and < keys adjust the value. For instance, to increase the COM radio frequency press CTRL C followed by one or more > keypresses.
5. Use the CTRL key as you would a SHIFT key. Hold it down and then press the desired letter key, keeping CTRL down until the letter key is released.

Flaps

The Y and N keys raise and lower the flaps. The Archer II has four flap settings or notches: up, 10, 25, and 40 degrees. The flaps are raised and lowered

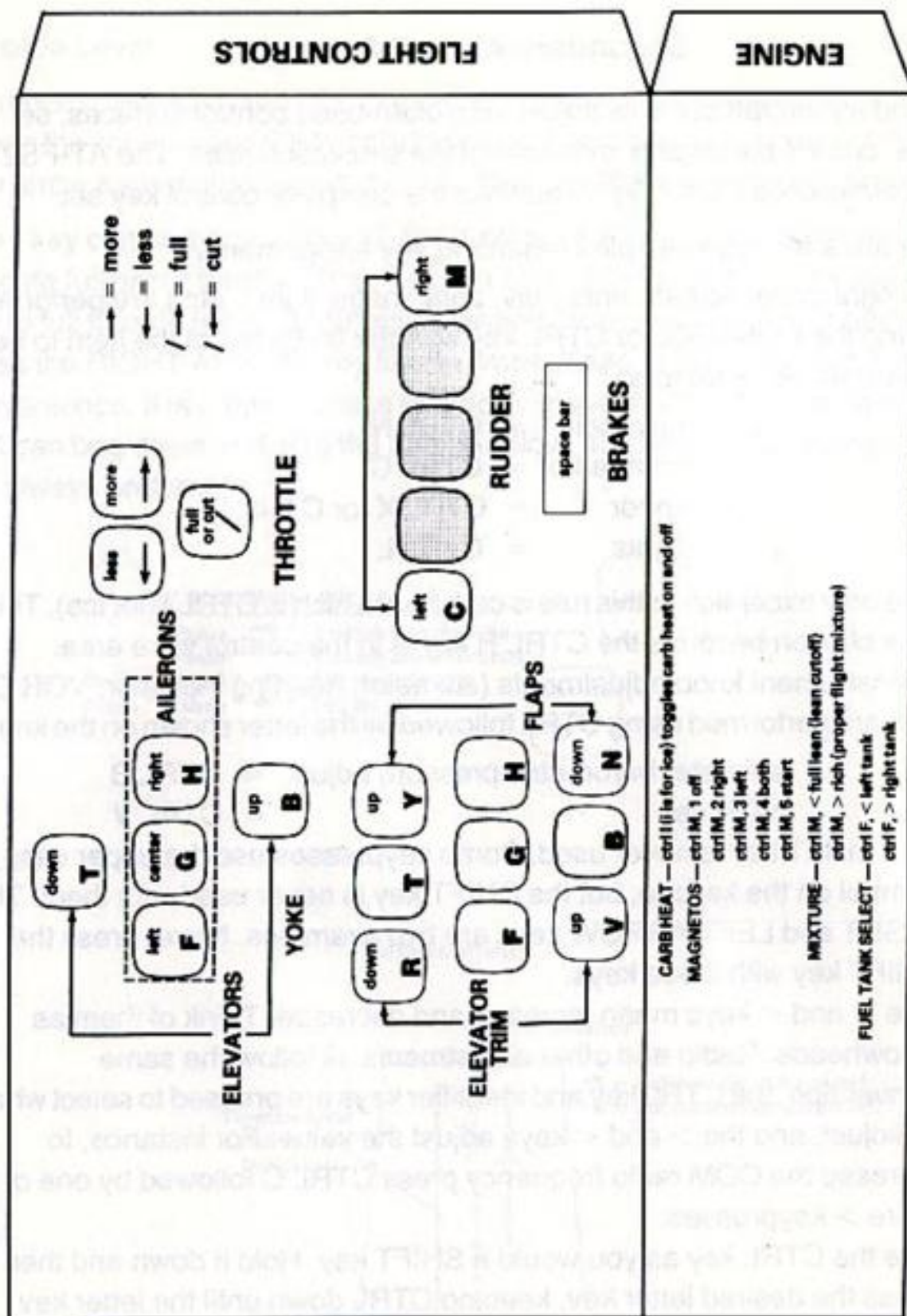

Figure 7. AT-FS2 Flight Reference Card

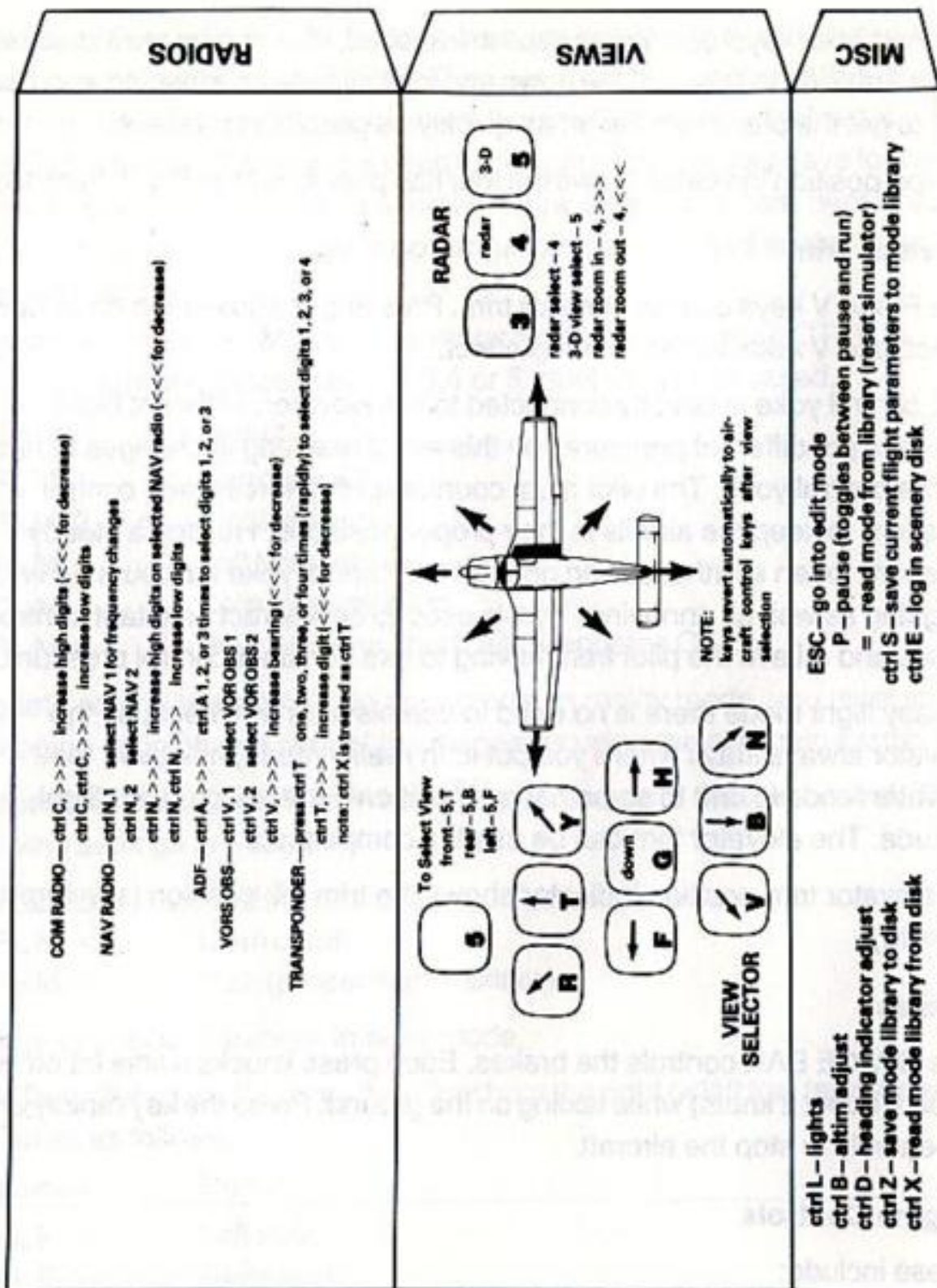

Figure 7. (continued)

one notch per keypress. When flaps are applied, lift and drag are increased. Flaps are used to slow a plane down and lose altitude on a landing approach and to get the plane into the air as quickly as possible on takeoff.

A flaps-position indicator shows the four flap positions (see Fig. 1, item 13).

Elevator Trim

The R and V keys control elevator trim. Pressing R adds to the nose-down effect, and V adds to the nose-up effect.

The control yoke is directly connected to the elevator. Different flight attitudes put different pressures on this airfoil resulting in changes of force on the control yoke. The pilot must counteract this force using control pressure to keep the airfoils in their proper positions. Holding a steady pressure (often a rather strong one) on the control yoke for hours on end is fatiguing as well as annoying. *Trim* is used to counteract constant control forces and relieve the pilot from having to use constant control pressure.

In easy flight mode there is no need to use elevator trim because the elevator always stays where you put it. In reality mode, however, the elevator tends to drift to some natural position depending on the flight attitude. The elevator trim can be used to compensate.

An elevator trim-position indicator shows the trim tab position (see Fig. 1, item 12).

Brakes

The SPACE BAR controls the brakes. Each press knocks a little bit off your speed (about 2 knots) while taxiing on the ground. Press the key rapidly and repeatedly to stop the aircraft.

Engine Controls

These include:

1. Carb heat
2. Magnetos
3. Mixture control
4. Fuel tank selector

Carb Heat: The CTRL I key is the carb heat control. Carb heat can be turned either on or off by pressing CTRL I. The C.H. indicator on the instrument panel (Fig. 1, item 31) indicates its state. It reads C.H. when carb heat is off, and HEAT when on. Carb heat is used to clear any ice that may have formed in the carburetor. It's a good idea to give a few seconds of carb heat while on a landing approach so there is no danger of an ice-caused engine failure during the landing.

Magnetos: The CTRL M key is the magneto switch. Pressing CTRL M begins a 2-key sequence. Key 1,2,3,4 or 5 must then be pressed.

Sequence	Result
CTRL M, 1	Magnetos Off
CTRL M, 2	Right Magneto On
CTRL M, 3	Left Magneto On
CTRL M, 4	Both Magnetos On
CTRL M, 5	Start Airplane, then Both Magnetos On

Magneto control is automatic in easy mode. In reality mode, you must start the engine yourself and control the magnetos using the magneto switch.

Mixture Control: The CTRL M key also serves as the mixture control. The following settings are used:

Sequence	Result
CTRL M, <	Lean cutoff
CTRL M, >	Rich (proper flight mixture)

Mixture control is automatic in easy mode.

Fuel Tank Selector: You may draw fuel from the right or left fuel tank. Select fuel tanks as follows:

Sequence	Result
CTRL F, <	Left tank
CTRL F, >	Right tank

The fuel selector indicator (Fig. 1, item 26) points to the selected fuel tank.

Fuel management is important, especially on long flights. Fuel is stored in the aircraft's wings and if you use only one tank, that tank's wing will become much lighter than the other wing causing an imbalance that you must compensate for using control pressure.

The left and right tanks each last about an hour. If the engine dies unexpectedly, check the fuel gauges and switch tanks if one is dry.

Radio Controls

These controls perform:

1. COM radio frequency adjustment.
2. NAV radio selection between NAV1 and NAV2.
3. NAV radio frequency adjustment.
4. VOR OBS selection between VOR1 and VOR2.
5. VOR OBS adjustment.
6. Transponder squawk code adjustment.
7. ADF receiver frequency adjustment (64K ONLY).

NAV and COM Frequency Adjustments: The adjustment method reflects aircraft NAV radio adjustments. On real radios, two knobs are used. One sets the full megahertz frequencies (121, 122, 123, etc) and the other sets the fractional frequencies in 50 kHz steps (.00, .05, .10, etc). Many new radios are 720 channel models that work with 25 kHz steps, but none of these in-between frequencies are used in the flight simulator.

To set the full megahertz frequencies, hit the CTRL C key for the COM radio (CTRL N for NAV) followed by one or more > or < keypresses to increase or decrease the frequency as needed. To set fractional frequencies, press CTRL C twice in rapid succession followed by > or < keypresses as needed. Summarizing:

Advance From 121 to 126 MHz: CTRL C, >>>>>

Advance From .35 to .55: CTRL C, CTRL C, >>>>>

The CTRL N key will adjust the most recently used NAV radio. To select between NAV1 and NAV2 radios, press:

Select NAV1: CTRL N, 1

Select NAV2: CTRL N, 2

After CTRL N is pressed, the NAV frequency selector accepts keypresses in almost any order. You may freely mix 1,2,<, and > keypresses to adjust and switch between radios after the single CTRL N key press.

The ATIS message is presented once after the COM radio is tuned. Press CTRL C three times in rapid succession to repeat the ATIS message.

Omni-Bearing Indicator Adjustment: The OBI's course set knob can be "turned" by typing CTRL V followed by > or < keypresses to change the course and reciprocal course readings. The letter "V" appears on the knob as a CTRL V reminder.

Select between OBI 1 and OBI 2 by pressing CTRL V,1 and CTRL V,2 respectively.

Transponder Adjustment: A four-digit code must be set on the transponder when ATC (air traffic control) requests it. Real transponders usually have a knob for each of the four digits. The FS2 simulates four knobs. To set the transponder, choose which digit you need to change. To change the leftmost digit, hit CTRL T followed by > or < keypresses as needed. To set the second digit, hit CTRL T twice followed by > or < keypresses. Press CTRL T three or four times to select the third and fourth digits. The multiple CTRL T keypresses should be performed in rapid succession.

ADF Adjustment: A three-digit frequency code can be set on the ADF receiver. One, two, or three rapid CTRL A keypresses select the left, mid, and right digits respectively. Follow selection with > or < keypresses as needed to change the selected digit:

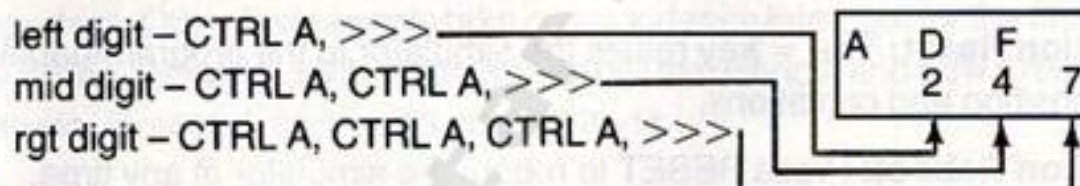

View Selector

The normal 3D view is out the front windshield. The view selector allows you to select from nine viewing directions. To select a view direction, press the 5 key, then press the key corresponding to the direction of view on the control diamond (see Fig. 7). After the view is selected, the control diamond reverts to its normal control functions.

Radar Selector

The FS2 has a *radar view* feature. The radar view appears on the 3D display area when radar is selected by pressing the 4 key. The > and < keys are used to adjust the radar's sampling range and act as zoom-in and zoom-out controls. The 3D view is deactivated when radar is in use. To return to 3D display mode, press the view selector (5) key.

Miscellaneous Controls

Lights: The CTRL L key turns on the navigation and instrument lights. Lights must be turned on to see the instrument panel at night. It's not advisable to fly with lights on during the day. If you do, when night arrives you may find that a bulb on an important instrument is burned out. Burned out bulbs are replaced during refueling and servicing.

Altimeter Adjustment: The CTRL B key sets the altimeter to current correct barometric pressure. Simply pressing the key sets the correct value. You may notice the altitude reading change when this key is pressed. A "B" is written on the altimeter's adjustment knob as a CTRL B reminder.

Heading Indicator (directional gyro) Adjustment: The CTRL D key sets the heading indicator to the proper direction using the magnetic compass as a guide. Make sure the magnetic compass is settled down before pressing the CTRL D key or an incorrect direction may be used to set the heading indicator. A "D" is written on the heading indicator's adjustment knob as a CTRL D reminder.

Simulation Pause: The P key causes the simulation to pause. A second P keypress resumes simulation.

Simulation Reset: The = key resets the simulator to the programmable restart position and conditions.

Simulation Reboot: Press RESET to reboot the simulator at any time.

Keyboard Techniques

Please keep the following item concerning keyboard control in mind when flying.

Simultaneous Keypresses

The keyboard handling system only samples the keyboard 15 times per second. Never exceed the 15 presses per second limit. Never press two keys simultaneously. This surely will exceed the limit. If two keys are pressed without at least a fifteenth of a second between them, the latter key is ignored.

Flying the Aircraft

When the simulator is started, the aircraft is on the ground at Chicago's Meigs Field, a small airport on a peninsula surrounded by Lake Michigan. The plane is on runway 36 (indicating a 360-degree heading) facing north. The John Hancock Building and other city buildings are in view. The engine is running and the plane is cleared for immediate takeoff. At this time, navigation is secondary to flight control. This section explains how to get into the air, maneuver the plane, and land.

Flight Under VFR Conditions

On startup, the weather is fair. The sky is blue and the ground green indicating a clear day without a cloud in the sky. No winds are present. This is perfect weather for VFR (Visual Flight Rule) flying. A pilot flying VFR (as opposed to flying IFR under Instrument Flight Rules) makes only moderate use of the flight instruments and relies on ground references and the visible horizon for aircraft navigation and orientation. The most important instruments on your first VFR flight are the airspeed indicator and altimeter. The aileron, rudder, elevator, and throttle position indicators are also important. Other instruments take on importance later, but for the first flight, we will be concerned with what is seen out the window and how it relates to altitude, airspeed, bank, and pitch attitude.

Getting Familiar with the Aircraft

If this is your first time in the plane, it is time to get familiar with it. Notice your altitude. Altitude is measured as feet above sea level, and although you are sitting on the ground, the altimeter reads the airport elevation (a few hundred feet above sea level). Also notice the compass and gyro compass. They have similar but seldom identical readings. The compass is read in degrees. A 270-degree reading corresponds to the aircraft pointing west.

It is visually obvious when the aircraft is standing still. The airspeed indicator is at its minimum position (readings don't start until 40 knots) and everything in the 3D display is still. When the aircraft is still, you can experiment with control movement. Turn the yoke full left then full right (using the F and H keys). Also try the elevator (T and B keys), rudder pedals (C and M) and centering control (the G key). Don't try the throttle yet.

Now is a good time to try the view selector. You are initially looking straight ahead. To look to the right front side, press 5 followed by the H key. Figure 7 outlines the view selector keys. The view selector keys are positioned for convenience and rapid selection. You must be aware of the view direction you have selected in order to keep from getting disoriented. It's a good idea to always revert to front view before getting involved with other flying tasks (adjusting NAV radios, setting up an approach to landing, etc.).

The radar view is a valuable aid when on the ground. The radar image is unrealistically accurate and is more like a map display. It can guide you around airports and help with navigation in general. Select the radar display by pressing the 4 key. The > and < keys can be used to zoom in and out. The 4 and 5 keys are next to each other. You can switch between radar and 3D visual display by alternating between these two keys. The 5 key normally requires a view selection key to be typed after it. This is not the case when switching from radar to 3D viewing mode. If you want to select a new viewing direction after switching from radar to 3D mode using the 5 key, you must type a complete view selection sequence (5 followed by view direction number).

Taxiing

When on the ground you are, unfortunately, at the point of the flight where the 3D out-the-window display is at its worst. This is due to the limited vertical resolution of the screen. While on the ground, everything gets cluttered on the horizon because most objects are viewed edge-on. It is often hard to make out taxiways until you are close to them. Radar view is quite useful when taxiing.

Begin taxiing by applying a bit of throttle (RIGHT ARROW). One notch is enough. In the 3D display, you will notice things start to move. The radar display shows a top-down view of where you are headed.

Try turning the rudder from left to right. The rudder ground-steers the plane by controlling the aircraft's nose wheel, and the plane can be steered like a car using the rudder pedals. If the throttle is cut, the plane will eventually roll to a stop. If you require a quicker stop, use the brakes (hit the SPACE BAR key repeatedly). You must be moving to turn the airplane. Practice taxiing around the airport to get an idea of what low-level scenery looks like.

Pre-Takeoff Check

Once you are familiar with taxiing, it is time to take off, but first you must do your pre-takeoff check. Go to the end of the runway (either end is OK for now), point down the runway, and line the plane up with the center line. Reduce throttle to zero and coast to a stop (use the brakes when necessary). Now, go through this checklist:

Pre-Takeoff Check List

1. Check for proper elevator operation. Move the elevator up and down and finally center it.
2. Check the rudder and ailerons in the same way. Center them.
3. Check the engine gauges. Make sure that the oil pressure and temperature are correct and that you have plenty of fuel. Check the heading indicator against the magnetic compass and set it if necessary (press CTRL D).

Note: A checklist used in a real aircraft has many more steps than this one. It's hard to remember all the steps for safe startups, takeoffs, and landings. The aircraft manufacturer provides many check lists with the aircraft, and it's good to get into the habit of always using them.

Takeoff

It may be a good idea to read the section on turns, climbs, and glides before takeoff, but because this is a simulator, you may just takeoff now and cross those bridges as you come to them.

If you are ready, here goes. Get ready to steer the plane as it rolls down the runway. Small adjustments in steering are preferable to wild zig-zagging. Now – FULL THROTTLE. Keep the plane on the runway. You should be looking out the front windshield. Keep half an eye on the airspeed indicator. It will start to rise. When you reach 48 to 53 knots you can begin your rotation (the point where you start to pull back the yoke and raise the nose to put the plane in its climb attitude to get off the ground). About two notches of nose up (elevator up, pull back on the yoke) is about right. You will notice the runway drop away as you lift off. You will see the nose pitch up and the vertical velocity indicator start to show a positive reading. You are airborne.

Climbing

The FS2 has the stability of a real aircraft when climbing. It essentially climbs by itself without the need for constant adjustments. After takeoff with full throttle and a notch or two of up elevator the plane should be in a steady climb.

When climbing, you can increase your rate of climb by increasing the throttle setting (assuming you are not at full throttle already) while holding a constant airspeed with the elevator. If you increase the throttle setting without raising the nose, your airspeed instead of your climb rate increases. By raising the elevator, you convert airspeed into vertical velocity.

The relationship between speed, vertical velocity, elevator and throttle is complex. Practice flights will get you familiar with the characteristics.

Non-pilots are cautioned against trying to attain an increased or decreased climb rate by merely pulling back or pushing in the yoke without adjusting throttle appropriately to keep airspeed steady. Raising the elevator alone will indeed increase your climb rate for a few seconds, but soon your airspeed will drop as you lose momentum and you will either stall or drop to a dangerously low airspeed. Down elevator alone will put you into a screaming dive.

Straight and Level, Constant Altitude Flight

Again, the FS2 acts as a real aircraft when in straight and level flight. The most common problem in holding a constant altitude is slowly drifting from your desired altitude by getting careless and not checking the altimeter once in awhile.

The transition from climb or glide to straight and level flight should be gradual. Use elevator and throttle to gradually get desired speed with no climb or drop. Don't chase the vertical velocity indicator. This can get you into trouble. After making small corrections using the altimeter and airspeed indicator as guides, you will find that your vertical velocity settles down nicely to near zero.

Glides and Descents

Glides and descents are used to reduce altitude with little or no engine power. Proper glide technique is essential for performing landing approaches.

In a climb, you increase throttle and raise the elevator to increase altitude so it seems logical that you would want to lower the elevator and decrease throttle for a glide. This is not the proper procedure. When you decrease the throttle, the plane naturally tends to drop its nose too far. Airspeed will start to rise if you decrease throttle and hold a straight and level elevator position (or lower the elevator) and decrease throttle. Again, your elevator should be used to hold your airspeed constant at the desired glide speed. A bit of back pressure on the yoke (up elevator) should be used to keep the nose from dropping.

Judging how much up elevator to use takes experience. You have to learn to watch the world outside when you decrease throttle. Get to know your pitch attitudes in glides.

To practice glides, go up to 5000 or 6000 feet, get straight and level, cut throttle to zero, and see what happens. If your airspeed gets dangerously high (over 140 knots or so) give a notch of up elevator. Raise the nose to get out of the dive you are in.

Flaps are useful during descents. Lowering the flaps provides extra lift and increases drag. You can increase your glide angle using flaps, which is useful if you are too high. Flaps also decrease stall speed which also is desirable while making an approach and landing. Use the Y and N keys to apply flaps as needed. The flap indicator (Fig. 1, item 13) shows flaps position.

Turns

The FS2 in self-coordinated flight mode automatically links ailerons and rudder thereby making turns simpler than in most real aircraft. The thing to remember about turns is that banking causes the turn. The aileron/rudder controls cause the plane to go into a bank.

The best way to learn about turns is by trying them. Get into straight and level flight. Give one notch of left rudder or aileron. You will start to bank.

Wait until the horizon appears to be banked 10 to 20 degrees. Now center the rudder/aileron. You will remain in the turn until you "roll out" of it. The FS2 is positively stable and wing dihedral effects are considered, so the plane will gradually straighten itself out if a roll-out isn't manually performed.

Roll-out timing is important. If you want to get on a heading of 180 degrees, you must start to roll out of the turn (by giving right aileron/rudder) about 10 degrees before 180 degrees is reached. It takes time to get level again and in the process of leveling off you are still turning.

A 10- or 20-degree bank is a shallow turn. After the turn, look at your altimeter. You may have lost a bit of altitude. In turns, planes tend to lose altitude, and the steeper the bank, the worse it gets. A bit of up elevator while in a turn solves this problem.

Landing

The hardest aspect of flying is landing safely and correctly. The idea of landing is to fly the plane a foot or two above the runway's surface and slow down until the plane stalls and stops flying. As the plane slows down, the nose will want to drop and the plane will try to fly itself into the ground, but you must compensate with elevator to keep the plane at the one- or two-foot level until it stalls. If you fly the plane onto the ground above stall speed, it may bounce.

As you pull back the yoke, the plane will take a higher and higher nose-up attitude. This is good. When you finally touch down, your elevator will be nearly all the way up.

You will know when you touch the ground. The scenery outside will level off and there will be an appropriate sound.

The process of getting to level flight above and aligned with the runway takes some practice. Steep glides are preferred as you come in for a landing. An engine failure while in a steep glide will have little effect on where you land whereas an engine failure on a long, shallow power glide at treetop level will drop you into the field half a mile from the airport. The idea is to align yourself with the runway and glide toward it in a steep glide at approach speed (about 75 knots indicated airspeed and 66 knots with flaps extended on final approach). You must then break the glide and transition

into straight and level, power off flight a few feet above the runway. This transition is known as the *flare*.

You will use aileron and rudder to align yourself with the runway as you come in for a landing, but make sure that the aircraft and rudder are straight when you touch down. If they are not, ground steering will whip you off the runway because your wheels aren't aligned to make the plane go straight. An abrupt turning of the plane on the ground is known as a *ground-loop* and could severely damage a real aircraft.

Once on the ground, you can use brakes to bleed off extra speed and come to a stop. You will then be ready for your next flight. You may wish to taxi to the ramp area to top off the tanks and turn around.

Before taking off again, make sure to do the pre-takeoff check. You will usually find that you have to center the elevator which is nearly all the way up from the last landing. Taking off with full up elevator and full throttle can be disastrous.

Aircraft Refueling and Servicing

Many major airports have fuel and servicing facilities. Fuel and servicing areas are marked by rectangles with "F"s inside them. These areas are found at the airports' ramp area. To refuel and have your aircraft serviced, come to a full stop within one of these areas.

See the area charts to determine which airports have refueling facilities.

Custom Simulator Modes

An editor that lets you change various flight and environmental parameters and a mode system that lets you save flight situations will now be described.

The Editor

Thirty-five parameters control the flight simulator's flight and environmental characteristics. The editor allows you to get at these parameters and create your own flight modes and create situations to begin flying from.

Entering the Editor

When the simulator is running, the editor can be entered by pressing the ESC (escape) key. A large alphanumeric menu will appear on the screen. The left area lists adjustable parameters, and the right column presents the current values of these parameters. These are the *current flight* parameters.

Using the Edit Arrow

The arrow immediately to the left of the parameter values points at the parameter to be *edited*. Move this arrow to the item you want to change by hitting the RETURN key repeatedly. You can back-step the arrow by hitting the - (minus) key. When the edit arrow points at the correct item, simply type in the value you want followed by RETURN. The DELETE BACKSPACE key works for corrections when entering new values. Entering a new value changes the simulator's current flight parameters. For example, if you change the altitude value from 500 to 9830 feet, the simulator will resume flight from 9830 feet when you exit back to flight mode.

Exiting the editor

Hit the ESC key to return to flight mode.

Current Flight Parameters

The current flight parameters now will be covered and their ranges specified. It is advisable to stay within the specified ranges. If you decide to try out-of-range values, be aware that internal values are 1, 2, or 3 bytes. If numbers larger than those specified are used, overflow can result.

When a modification is entered, it changes one of the current flight parameters. All screen data is then updated so you can see what really went into the parameter. The screen updating is too fast to see, but is sometimes noticeable as a small flash.

Simulation Control

USER MODE: This is the mode library pointer. Any current flight parameter load or save will come from or go into this user mode in the User Mode Library.

SOUND: A zero turns sound off. A one turns the sound on.

AUTO COORDINATE: A one causes aileron/rudder linking and automatically coordinates the flight. A zero allows rudder and aileron to be used separately.

SLEW: A zero turns the slew system off, and a one turns it on. With the slew system turned on, you can "escape" back into flight mode and slew controls will replace the normal aircraft flight controls and action (see **World Navigation** section).

REALITY MODE: A zero enables easy flight. A one adds realistic flight factors and makes things more difficult (due to the realism). The following features are put into effect when reality = 1:

1. The engine must be started using the magneto switch and starter.
2. Too much throttle too quickly can kill the engine.
3. The elevator doesn't stay in the selected position continuously unless the proper trim setting is used.
4. You may get caught in the mud or a snow bank if you leave the runway.
5. The heading indicator will drift from the correct magnetic heading and must be set with the D (directional gyro) key.
6. The altimeter will register altitude improperly unless the barometric pressure is periodically set using the B (altimeter set) key.
7. When dusk turns to night, the instrument panel blanks-out except for the LED indicators in the radios. The instruments reappear when the lights are turned on.
8. Flying all day with the lights turned on can cause a burned out bulb on an important flight instrument. Burned out bulbs are replaced during refueling and servicing.

CAUTION: Do *not* use reality mode with a 48K system.

EUROPE 1917: This parameter, when set to zero or one, selects between normal flight simulation and WW I Ace aerial battle modes respectively. Once the wargame is selected, you must reboot to fly in simulation modes again.

COMMUNICATION RATE: This parameter controls the rate at which communication radio messages appear. The COM radio can be tuned to receive ATIS (Automatic Terminal Information Service) messages which appear above the instrument panel. A half page text display is used. The communication rate value determines text generation rate. The rate at which information is written on the screen ranges from very slow (1) to very fast (255).

Aircraft Position

NORTH and EAST POSITION: These values are submitted in world coordinates as specified in the area charts. Each unit represents 256 meters so positioning accuracy is only good to the nearest 256 meters.

ALTITUDE: This value is submitted in feet above sea level.

PITCH, BANK, HEADING: These variables have a range of 0 to 359 degrees. Heading is measured as compass heading. Bank increases clockwise and pitch increases as the nose rises.

AIRSPEED: This is submitted in knots.

THROTTLE, RUDDER, AILERONS, FLAPS, ELEVATOR: These controls are provided so you can set up "situations" for yourself or others to get out of. Upon escaping back into flight mode, the controls will be set at the submitted settings. The ranges of these controls are:

Control	Range	Reference
Throttle	0 to 32767	cut = 0
Rudder	1024 to 64512	center = 32767
Aileron	1024 to 64512	center = 32767
Flaps	0 to 24576	no flaps = 0
Elevator	12288 to 53248	center = 32767

Environmental Control

HOURS: This sets the hour of the day. The range is between 0 and 23 corresponding to the 24-hour timing system. This is local time, not Greenwich mean time.

MINUTES: This sets the minutes past the hour. The range is 0 to 59.

SEASON: The following codes should be used:

Code	Season
1	Winter
2	Spring
3	Summer
4	Fall

CLOUD LAYERS: These parameters adjust the lower and upper limits of the cloud layers. Bottoms (low altitude beginnings) and tops (high altitude endings) in feet above sea level are specified. The following diagram shows the menu entry meanings:

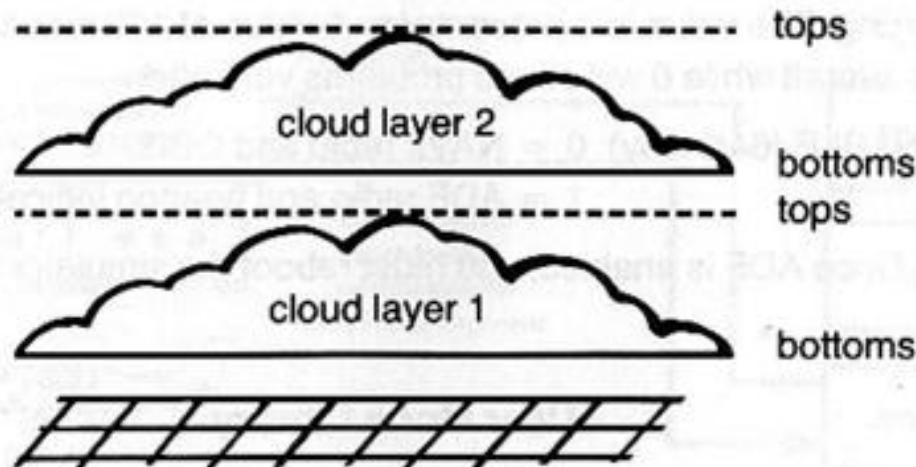

Make sure the tops are higher than the bottoms, and don't overlap the two cloud layers. To eliminate a cloud layer, set the tops and bottoms of the layer to zero.

WIND: Surface wind and wind at three levels can be specified. Set velocity in knots, direction in degrees, and shear altitude in feet above ground level. Shear altitudes mark the transition between two wind levels. The following diagram shows the menu entry meaning:

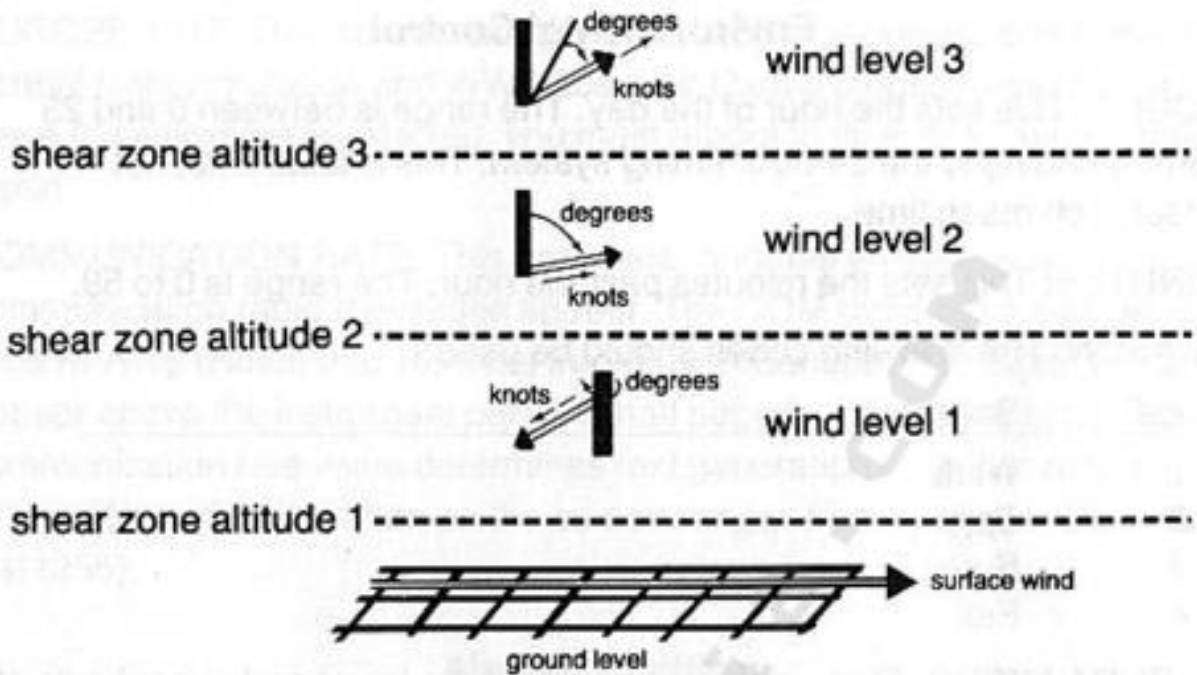

NOTE: Wind comes out of the direction pointed. A wind from 0 degrees blows from north to south.

RELIABILITY: In reality mode, engine and other problems can arise. This variable is a reliability measurement that regulates how often something goes wrong. The value is a percentage. A value of 100 results in a totally reliable aircraft while 0 will cause problems very often.

ADF ENABLE (64K only): 0 = NAV2 radio and OBI2.

1 = ADF radio and bearing indicator.

NOTE: Once ADF is enabled, you must reboot the simulator to use VOR 2 again.

User Mode Library

The parameter values you see on the edit page are the current flight parameters. They reflect the simulator's current North, East, Pitch, Bank, Heading, and other characteristics. These parameters change as you fly the aircraft.

A *User Mode Library* is available. You can store a complete set of current flight parameters (a mode) to the User Mode Library for recall at a later time.

In other words, you can capture the aircraft's position, attitude, and characteristics and restart it from the same position later on.

The USER MODE flight parameter (the first parameter on the first edit page) selects which user mode will be loaded from and saved to. There are 25 user modes in the User Mode Library (12 modes for the 48K version, see Fig. 8). You can save and load current flight parameters using the following keys:

Key	Function
=	Load current flight parameters from User Mode Library
CTRL S	Save current flight parameters to User Mode Library

You can press the = key while in flight mode to reset to a previously defined user mode. An interesting flight situation can be saved to the User Mode Library during flight by pressing the CTRL S key. The exact position, attitude, time, and season can be recalled from the library at a later time using the = key. You can use the CTRL S and = keys while in the editor.

Whenever you change the USER MODE parameter, the data from the mode library for the selected mode number is loaded into the current flight parameters. When you change user modes, an = keypress is automatically performed.

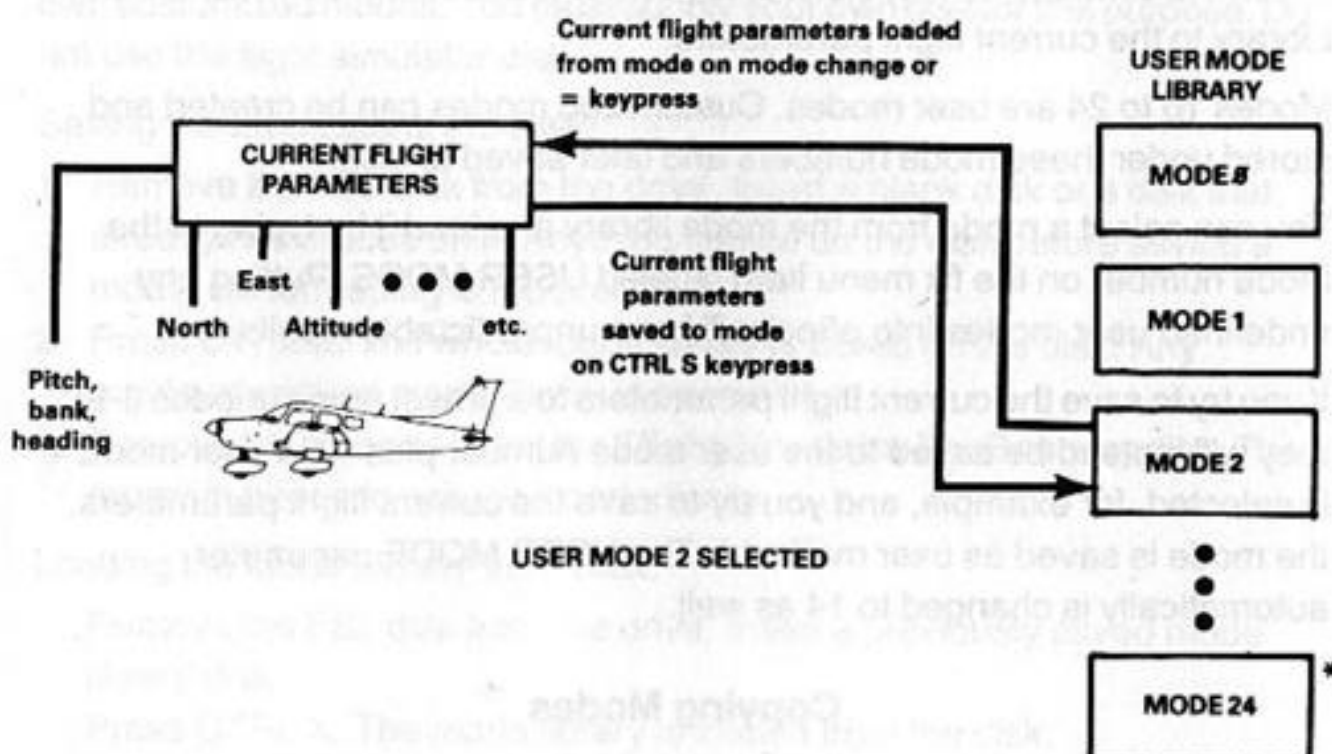

* 48K version only has modes 0 to 11.

Figure 8: User Mode Library

Ten of the modes in the library come set up with the simulator. These are *preset modes*. There are 25 modes numbered 0 through 24. Modes 0 to 9 are preset modes:

Mode	Function
0	Easy flight
1	Realistic, fair weather flight
2	Self-flight demonstration
3	Dusk flight
4	Night flight
5	Moderate weather flight
6	Bad weather flight
7	WW I Ace aerial battle game
8,9	Other preset flight modes
10,11	User modes
12-19	User modes and modified preset modes (64K ONLY)
20-24	User modes (64K ONLY)

When the simulator is first started, mode 0 is loaded from the User Mode Library to the current flight parameters.

Modes 10 to 24 are user modes. Customized modes can be created and stored under these mode numbers and later saved to disk.

You can select a mode from the mode library and load it by typing in the mode number on the fix menu item labeled USER MODE. Putting any undefined user modes into effect will have unpredictable results.

If you try to save the current flight parameters to a preset mode (modes 0-9), they will instead be saved to the user mode number plus 10. If user mode 4 is selected, for example, and you try to save the current flight parameters, the mode is saved as user mode 14. The USER MODE parameter automatically is changed to 14 as well.

Copying Modes

You very seldom will want to start a flight mode purely from scratch. Usually you will want to make a few modifications to an existing mode, try out the

changes and perhaps back track to the old flight mode if things don't work out right. Use the following procedure to copy modes:

1. Select the user mode you want to use as a model, and change the USER MODE parameter to it. The mode will be loaded into the current flight parameters.
2. Make any desired changes to the current flight parameters.
3. Decide which user mode you want to save the mode to. Add 100 to the mode number and change the USER MODE parameter to it. The current flight parameters will be saved in the mode you wanted to save them to.

Example: You want to copy mode 2 along with some changes to mode 24. Set the user mode to 2. Make your changes on the edit page. Set the user mode to 124. The changed mode is stored in mode 24 and the user mode is set to 24.

Saving and Loading the Mode Library to Disk

The User Mode Library resides in memory and is lost when you turn off the computer. You can save the User Mode Library to disk to avoid losing your own customized modes. You must supply your own disk for this purpose. Do not use the flight simulator disk.

Saving the Mode Library to Disk:

1. Remove the FS2 disk from the drive. Insert a blank disk or a disk that already has modes on it. Anything can be on the disk before saving a mode. No formatting is required.
2. Press CTRL Z. The whole mode library is saved on the disk. Any previously saved mode library is overwritten.
3. Remove the disk and insert the **Flight Simulator II** or **Scenery** disk. The program needs to access it periodically.

Loading the Mode Library from Disk:

1. Remove the FS2 disk from the drive. Insert a previously saved mode library disk.
2. Press CTRL X. The mode library is loaded from the disk.
3. Remove the disk and insert the **Flight Simulator II** or **Scenery** disk. The program needs to access it periodically.

CAUTION: Mode disks saved on 48K machines and 64K machines are not compatible with one another. Never use a 48K mode library disk in a 64K machine or vice versa.

Editor Key Summary

The following list summarizes keyboard functions in the editor:

Key	Effect
RETURN	Moves the edit arrow to the next line and enters any changes to the current line.
-	Back-steps the edit arrow.
DELETE	Backs up the cursor when entering data on a line.
ESC	Returns to flight mode (or slew mode if SLEW = 1)
CTRL S	Saves the current flight parameters to the User Mode Library at the mode number specified by the USER MODE parameter.
=	Loads the current flight parameters from the mode specified by the USER MODE parameter.
CTRL Z	Saves the whole User Mode Library to disk (see Fig. 9).
CTRL X	Reads the whole User Mode Library from disk.

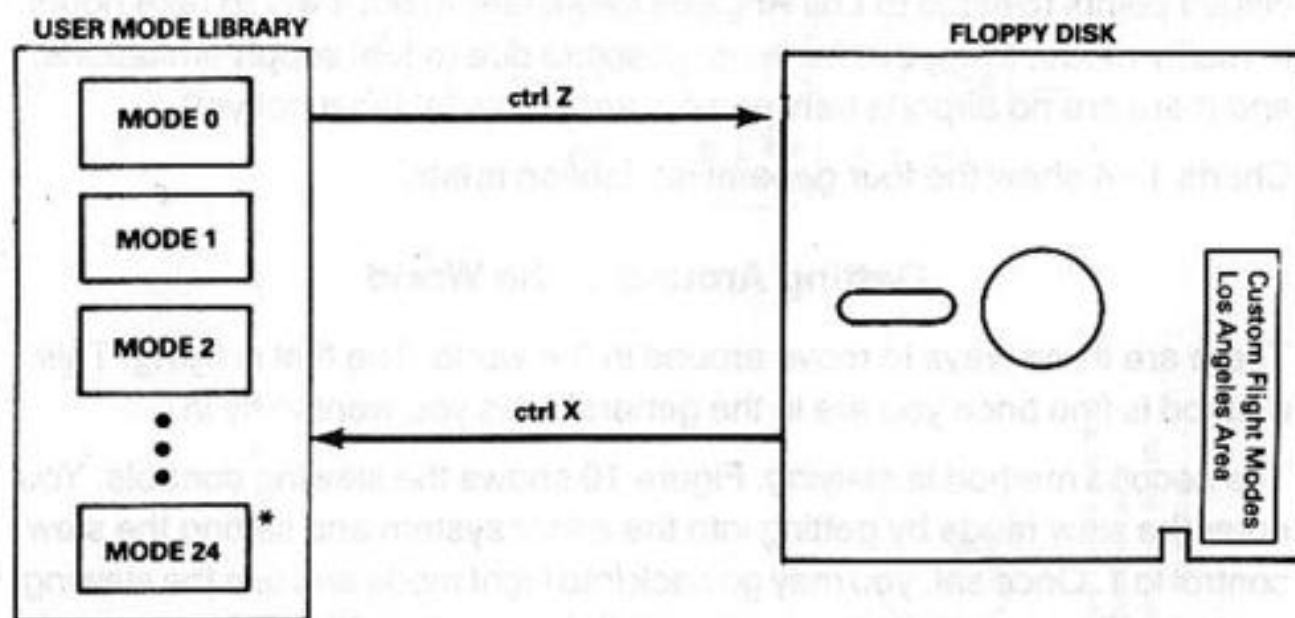

*Only modes 0 to 11 are available on 48K systems.

Figure 9. User Mode Library Saved to Disk

The "World" and World Navigation

The "world" in which you fly has a range of approximately 10,000 by 10,000 miles with a resolution of about 2.5 inches and a center coordinate ($x = 0$, $y = 0$) at 40 degrees latitude and 88 degrees 30 minutes longitude (about 30 miles southwest of Champaign, Illinois). The range covers the whole continental United States and extends well into Canada, Mexico and the Caribbean. Airports and other features were digitized directly from aerial photographs or taxi charts when no photographs were available.

World Specifications

The world database is currently limited to about 80 airports in 4 general areas (Seattle, Los Angeles, Boston/New York, and central and northern Illinois). The database is not very extensive considering the vast number of airports and topographic features in the United States and Canada, but everything that's there is in its proper place. Systems are provided to let you get from area to area quickly and easily. You could actually fly between distant points (Seattle to Los Angeles for instance) but it would take hours. In reality mode, flying this far is not possible due to fuel supply limitations, and there are no airports between distant points (at least not yet).

Charts 1 - 4 show the four general navigation areas.

Getting Around in the World

There are three ways to move around in the world. The first is flying. This method is fine once you are in the general area you want to fly in.

The second method is *slewing*. Figure 10 shows the slewing controls. You enter the slew mode by getting into the editor system and setting the slew control to 1. Once set, you may go back into flight mode and use the slewing controls. These controls have exponential properties. Fine movements can be made to examine airports closely, but slewing speed increases very rapidly and exponentially as you increase the slew rate (by repeatedly typing any slew key). You can thus slew great distances in very little time. The G key can be used to stop all slewing motion.

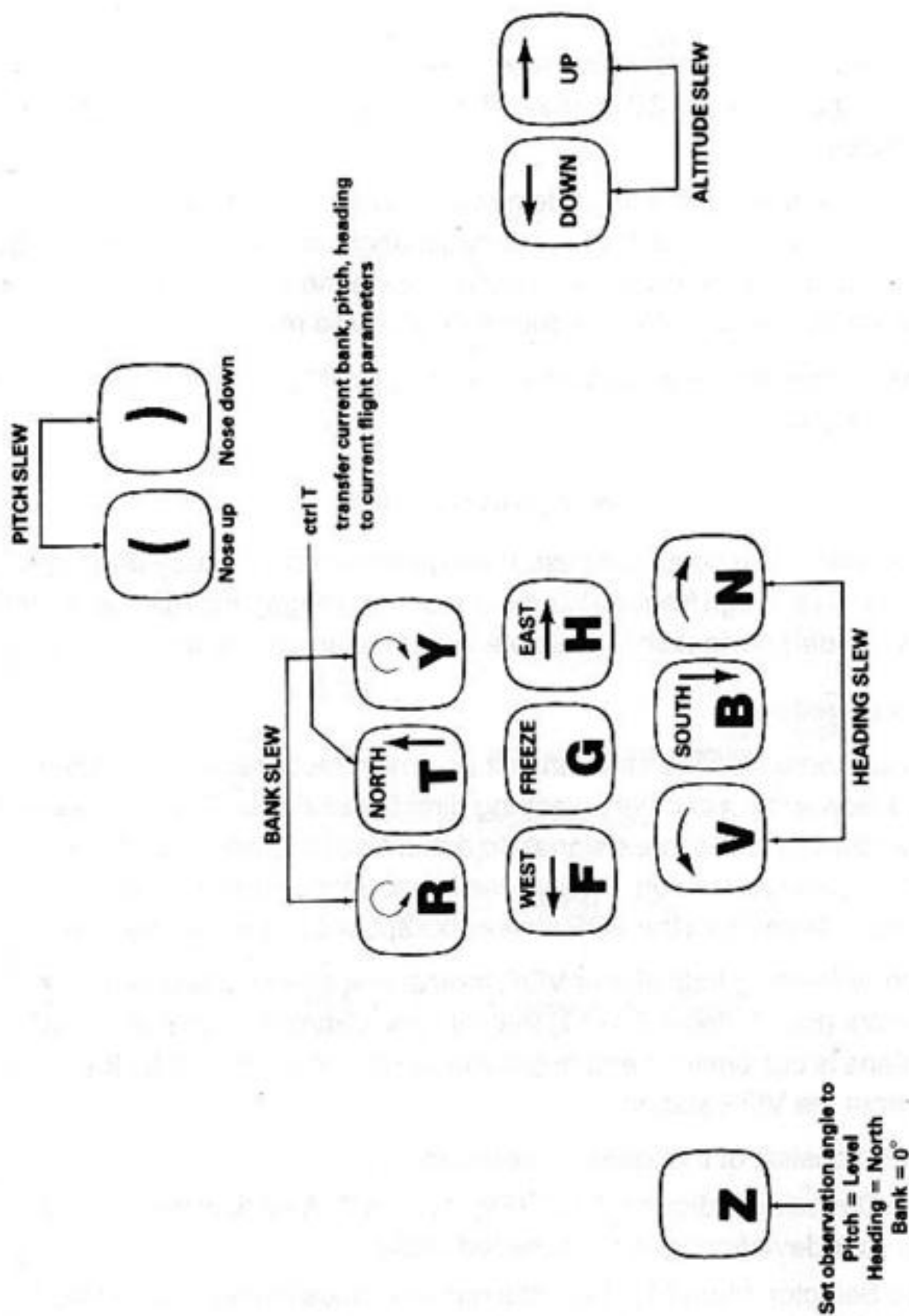

Figure 10. Slewing System Controls

When flight mode is entered with the slew system turned on, two indicators appear at the top of the 3D display. These indicate your north and east coordinates.

The third and fastest way to get to a precise destination is to go into the editor system and manually set your destination coordinates. North, east, and altitude coordinates can be specified using the editor. The coordinates to plug into these variables are shown on the area maps.

Setting altitude to 0 will always put you at the proper ground elevation for the selected area.

Navigational Aids

The FS2 has a few commonly used navigational aids. For day and night flight, VOR (very high frequency omnidirectional range) and ADF (automatic direction finder) navigation is available. Airport beacons are provided at night.

VOR Navigation

VORs are radio stations that transmit an omnidirectional synchronization signal followed by a circular sweeping directional signal. The NAV receiver in the aircraft decodes these signals to determine what angle or what radial from the station you are on. Radials can be thought of as directional beams radiating outward from the VOR station like spokes of a wheel (see Fig. 11).

The Omni-Bearing Indicator or VOR Indicator is a panel-mounted instrument (Fig. 1, items 6 to 11) that lets you determine what VOR radial your plane is currently on and helps you fly up and down radials toward or away from the VOR station.

The OBI consists of the following components:

Course Deviation Indicator (CDI): (Fig. 1, item 7) A vertical needle that shows your deviation from the selected radial.

Course Selector: (item 11) This is the numeric value that appears at the top of the OBI. This number shows what radial is selected.

Course Selector Knob or Omni-Bearing Selector: (item 6) A knob that adjusts the course selector. This is used to select the radial you want to fly on, or to find what radial you are intercepting.

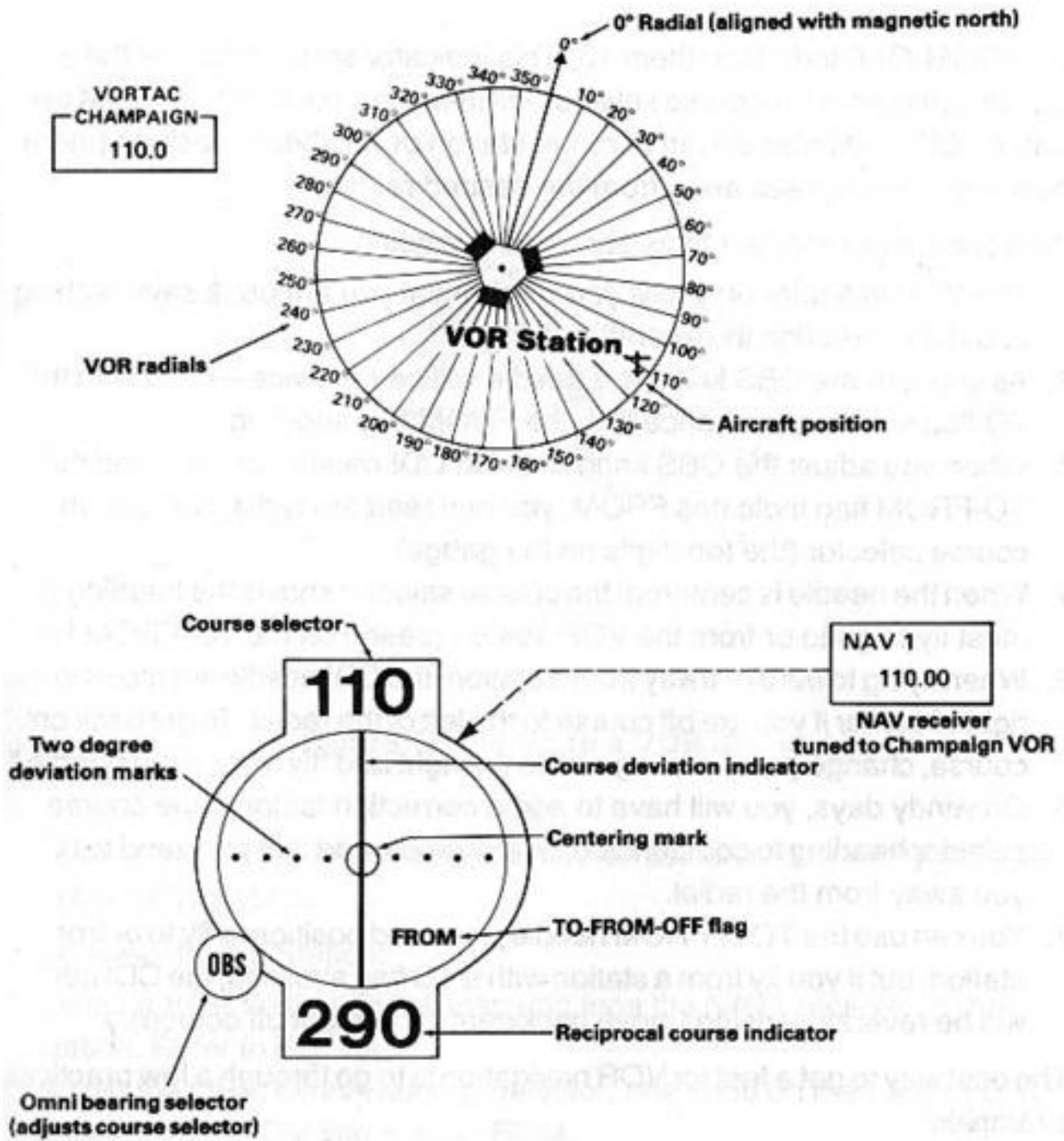

Figure 11. VOR Station, Radials, and Indicator

TO-FROM-OFF Indicator: (item 10) This indicator shows whether the course selected in the course selector will take the aircraft TO or FROM the station. OFF indicates an out of range station or an abeam position (more than about 75 degrees away from the desired radial).

Here are a few important facts about VOR readings:

1. The VOR indicator only tells you what radial you are on. It says nothing about the direction the aircraft is flying.
2. As you turn the OBS knob, the needle will center twice – once with the TO flag showing, and once with the FROM flag showing.
3. When you adjust the OBS knob until the CDI needle centers, and the TO-FROM flag indicates FROM, you can read the radial number on the course selector (the top digits on the gauge).
4. When the needle is centered, the course selector shows the heading you must fly to go to or from the VOR station (based on the TO-FROM flag).
5. When flying toward or away from a station, the CDI needle will move to the right of center if you are off course to the left of the radial. To get back on course, change your heading a bit to the right and “fly toward the needle.”
6. On windy days, you will have to add a correction factor to the course selector heading to compensate for any crosswind that may tend to blow you away from the radial.
7. You can use the TO or FROM needle-centered position to fly to or from a station, but if you fly from a station with a TO flag showing, the CDI needle will be reverse sensing (move backwards if you get off course).

The best way to get a feel for VOR navigation is to go through a few practical examples:

Flying Toward a Station:

1. Select a VOR station on the map and tune the NAV1 receiver to the station. Refer to Fig. 12.
2. Adjust the OBS, Omni-Bearing Selector (the knob on the upper VOR) until the TO-FROM flag reads TO. If the OFF flag appears for all OBI settings, you are either too far from the VOR station (station range is 30 to 100 miles) or the NAV1 radio is improperly tuned.
3. Adjust the OBS until the CDI (vertical needle) is centered. Make sure the TO flag is still showing.
4. The magnetic course to fly to the station can now be read on the course selector.

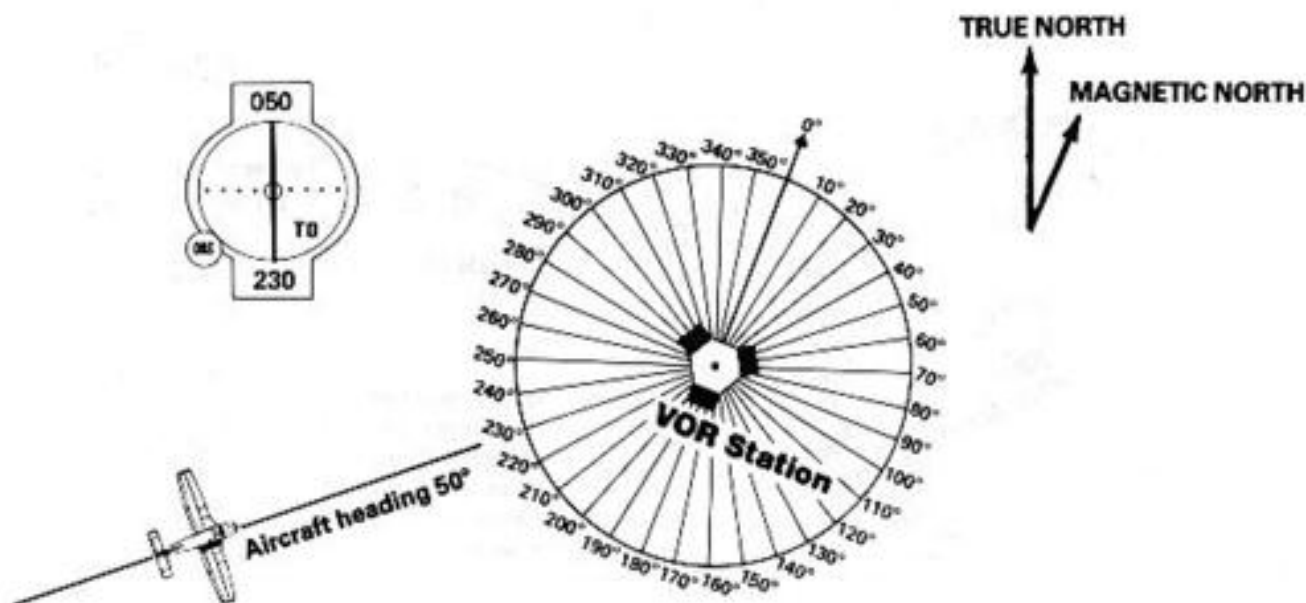

Figure 12. Flying to a VOR Station

5. Take up the course indicated by the course selector. This will fly you right to the VOR station.

Flying Away from a Station:

1. Select a VOR station on the map and tune the NAV1 receiver to the station. Refer to Fig. 13.
2. Adjust the OBS, Omni-Bearing Selector, (the knob on the upper VOR) until the TO-FROM flag reads FROM.
3. Adjust the OBS until the CDI (vertical needle) is centered. Make sure the FROM flag is still showing.
4. The magnetic course to fly from the station can now be read on the course selector.
5. Take up the course indicated by the course selector. This will fly you away from the VOR station.

Station Passage:

1. Select a VOR station that you want to fly past (TO on the selected radial and FROM on a radial of about 180 degrees difference). Tune it in, and fly TO it. Refer to Fig. 14.

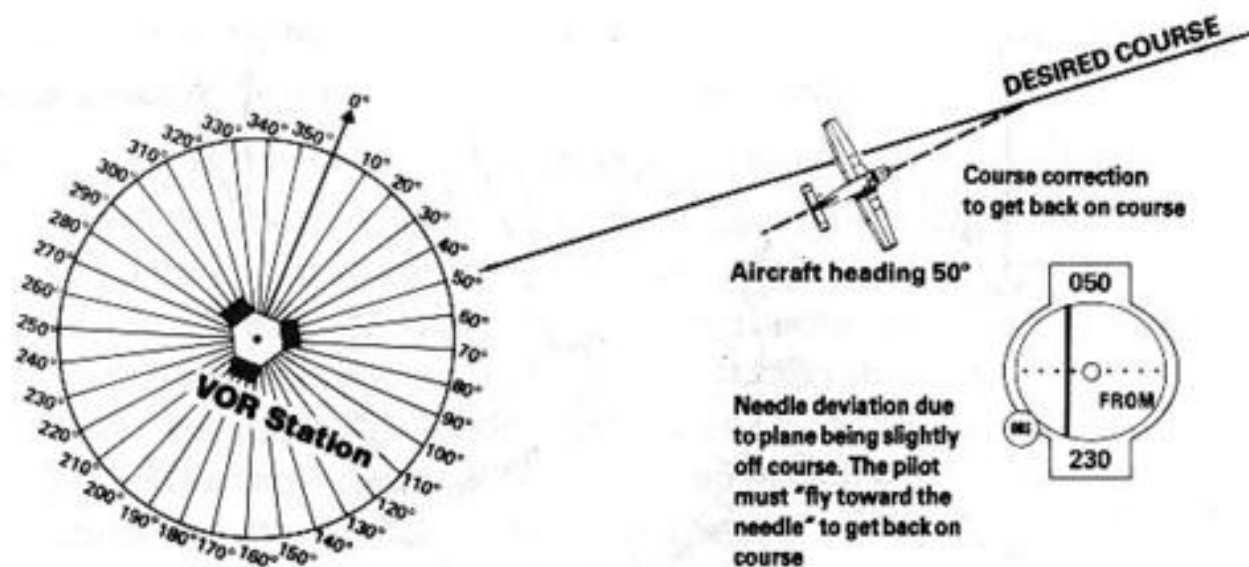

Figure 13. Flying from a VOR Station

2. When you get very close to the station, the needle will become hard to track. Radials are close together near the station they radiate from, and even small course errors show large deviations.
3. Don't chase the needle or try to keep it centered. Instead, fly straight on the heading indicated on the OBI until you get to the other side of the station.
4. You very rarely will fly right over a VOR station. If the station is a fair distance to the right or left of you (usually a mile or more), the OFF flag will appear indicating an abeam position and the CDI needle will pin itself to the side of the VOR gauge toward the station. You then know on which side of the station you are passing.
5. Shortly after station passage, the FROM flag will appear. Assuming you held your heading to the OBS course, the CDI needle will be nearly centered. You are now flying FROM the station as intended.

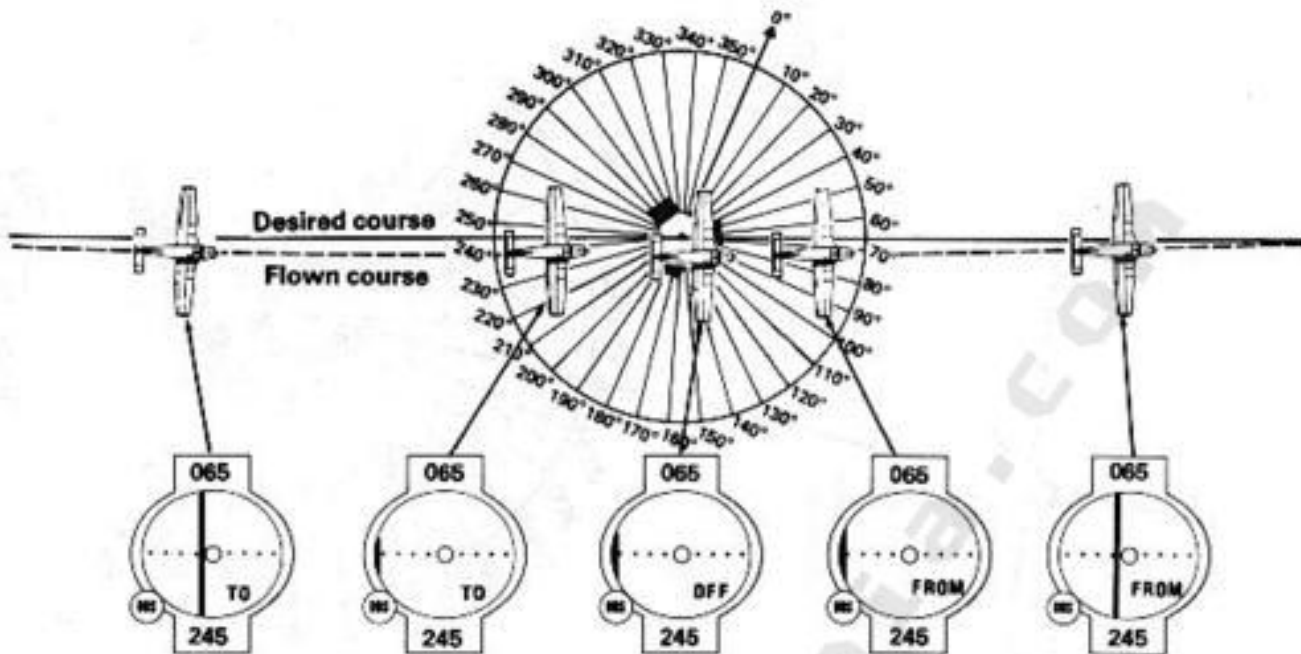

Figure 14. VOR Passage

Crosschecking Position:

1. Tune in two different stations on NAV1 and NAV2.
2. Adjust the OBS knobs on VOR indicators 1 and 2 until the FROM flags are showing on both. Read the radials you are on for both stations.
3. Look at your navigation chart and draw lines down the radials of the two VORs. The intersection of the lines is your position (see Fig. 15).

Flying from Station to Station:

1. Select 2 VOR stations that you want to fly between. You will be flying FROM station A TO station B. Draw a line on the map between them (see Fig. 16).
2. Tune in station A on the NAV1 radio.
3. Adjust the OBS on the upper VOR until the course selector shows the course you wish to fly from station A. This value can be read off the VOR degree markings on the map.

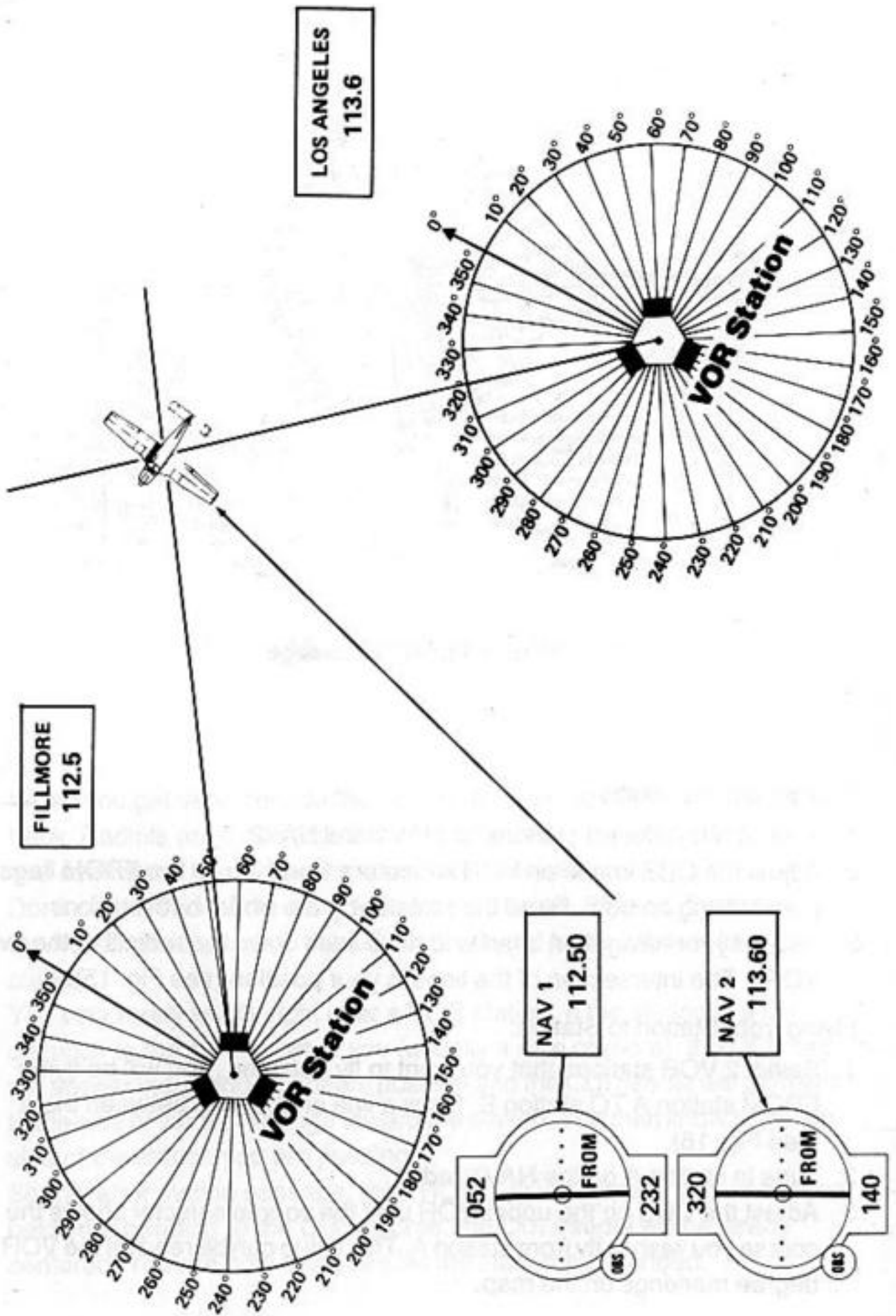

Figure 15. VOR Crosschecking

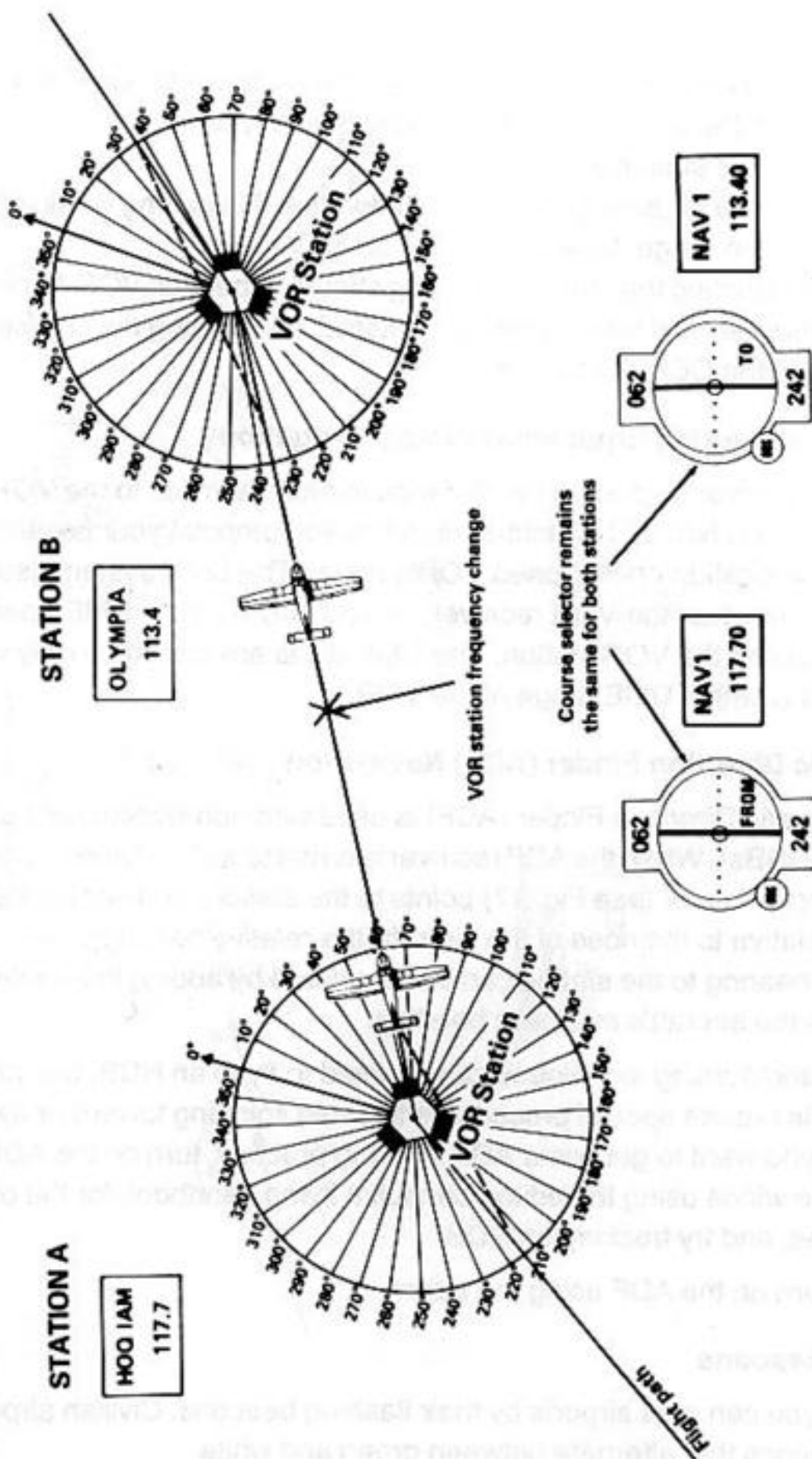

Figure 16. VOR Station-to-Station Navigation

4. Fly to the vicinity of station A and get on the radial and course just selected on the OBS. The FROM flag should appear.
5. Fly FROM the station as usual.
6. When you are far enough from the station that it is getting weak, or if station B is in range, tune in station B on NAV1.
7. Without adjusting the OBS, the TO flag should appear on VOR 1 and the CDI needle should be very nearly centered. Keep flying the course shown on the OBS TO station B.

Distance Measuring Equipment (DME) Navigation

The DME receiver measures the distance in nautical miles to the VOR station tuned on NAV1. This information lets you pinpoint your position by finding your location on the tuned VOR's radial. The DME system usually has less range than the VOR receiver, so you may have no DME operation yet be receiving the VOR station. The DME digits are turned on only when the aircraft is within DME range of the VOR.

Automatic Direction Finder (ADF) Navigation (64K ONLY)

The Automatic Direction Finder (ADF) is used with non-directional radio beacons (NDBs). When the ADF receiver is tuned to an NDB, the needle on the bearing indicator (see Fig. 17) points to the station, and shows the bearing relative to the nose of the aircraft (the *relative bearing*). The magnetic bearing to the station can be calculated by adding the relative bearing to the aircraft's magnetic heading.

Tracking and homing techniques can be used to fly to an NDB, but strong crosswinds require special procedures to avoid spiraling toward or away from it. If you want to get some ADF tracking practice, turn on the ADF and turn up the winds using the editor, consult a flying handbook for the proper techniques, and try tracking an NDB.

NOTE: Turn on the ADF using the editor.

Airport Beacons

At night, you can spot airports by their flashing beacons. Civilian airports have beacons that alternate between green and white.

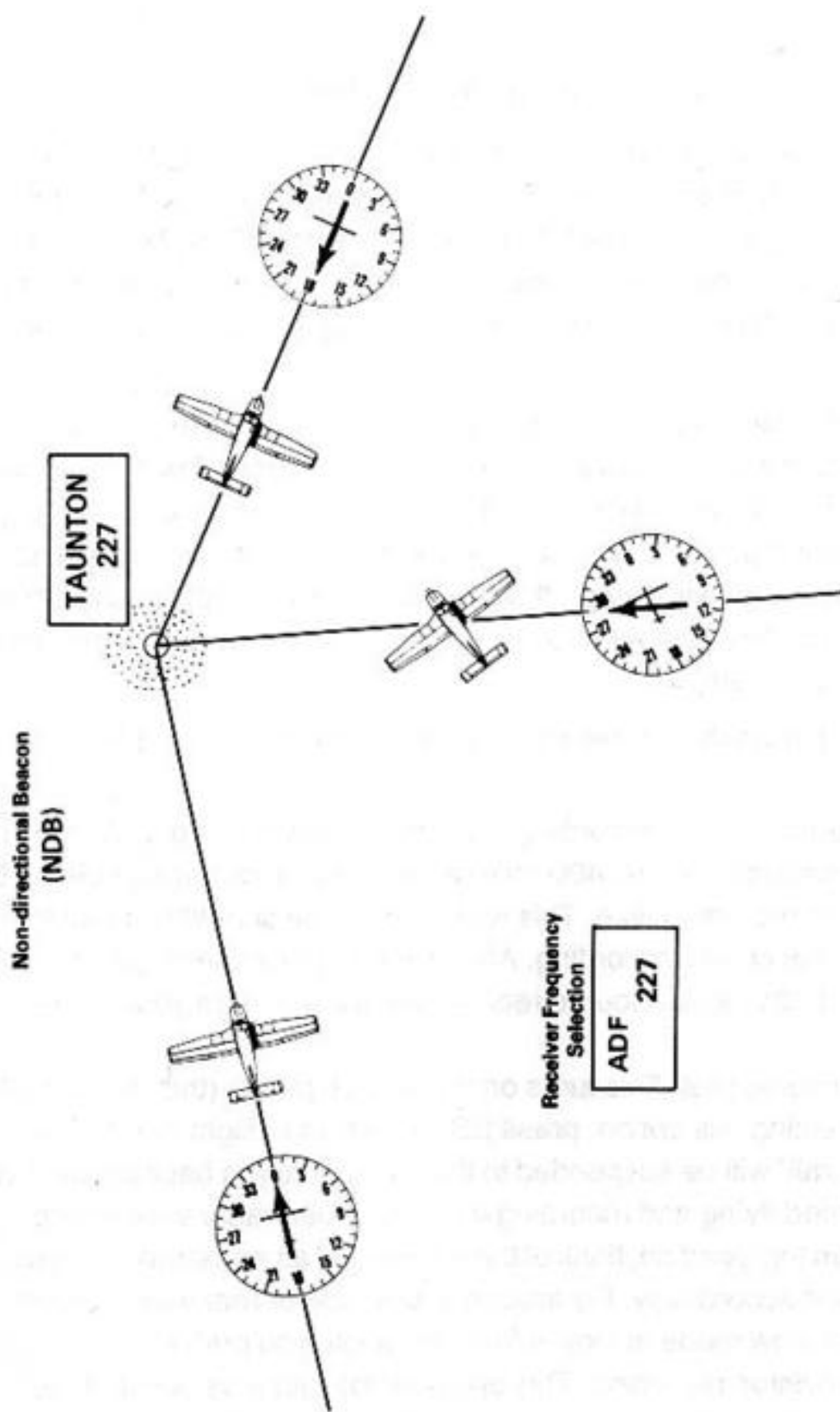

Figure 17. Automatic Direction Finder (ADF)

Course Plotting System (64K ONLY)

The course plotting system gives you a graphics screen readout of your flight course superimposed over the scenery over which you have flown. In course recording mode, the aircraft's three-dimensional position is recorded at preset intervals. When in course display mode, white line segments are drawn between these points. The white line string appears as a "smoke trail" in the sky.

Course display mode does not draw a preset map and plot the course on it. All it does is turn the "smoke trail" on. You must use radar view or visual view from the right position and direction to see the smoke trail. By slewing or flying to different positions you can see the course plot from the top (to indicate course against a map), the side (to judge your approach path and oscillations) or skewed angle (to see the results of loops, stalls, and other aerobatic maneuvers).

Press Q to activate the course plotting menu. The following options are available:

- A. **Begin normal course recording.** This starts recording your course in a coarse resolution mode: 400-mile range, 5 seconds per samples, 75 minutes of recording time. This recording mode should be used for navigational course recording. After selecting this option, press ESC to return to flight mode. Course recording will begin from your current position.
- B. **Display course plot.** This turns on the course plotter (the smoke trails). After selecting this option, press ESC to return to flight mode. The "smoke trail" will be suspended in the sky (usually in back of you if you just finished flying and recording a course). Use radar view to find the trail. From this point on, think of the smoke trail as an item in the scenery and view it accordingly. Fly around it, use side or rear views, use radar, or go into slew mode to view it from the angle you prefer.
- C. **Begin precision recording.** This option is the same as option A, but the sampling rate is higher, and the recording scale is finer: 25-mile range, 1-sample/second, 15 minutes of recording time. Use this mode to record landing approaches and aerobatics to get a precise record of the aircraft's flight path.

D. Turn off course plotter. This option turns the "smoke trails" off. The course is still stored in memory, however, and option B can be selected later to view the course again.

NOTE: Selecting either course recording mode (option A or C) erases all old course plot information and starts recording a new course in memory.

Environmental Factors

The FS2 simulates a few of the external environmental conditions that affect flying the most. These factors fall into three categories: time, weather, and random events.

Season and Time of Day

The seasons (winter, spring, summer, and fall) each present their own unique flying problems. Winter brings startup problems while summer brings hot humid days that increase density altitude and decrease lift resulting in longer takeoffs. A few of these characteristics are programmed into the simulator.

Setting the Season

The season is determined by the *season* variable that can be accessed using the editor. Move the edit arrow to the SEASON parameter and set it to 1, 2, 3, or 4.

- 1 = Winter
- 2 = Spring
- 3 = Summer
- 4 = Fall

The FS2 operates in three distinct visual flight periods: day, dusk/dawn, and night. The visual flight period is selected automatically based on the time of day.

A digital clock on the instrument panel indicates the current time. The *hour* and *minute* variables determine the time and can be accessed using the editor system. The clock is a 24-hour clock to allow consideration of AM and PM times.

The visual mode switch-over transition times are:

Season	Night to Dawn	Dawn to Day	Day to Dusk	Dusk to Night
Winter	7:00	7:30	17:00	17:30
Spring	6:00	6:30	19:00	19:30
Summer	5:00	5:30	21:00	21:30
Fall	6:00	6:30	19:00	19:30

Weather – Clouds, Winds, and Turbulence

The FS2 simulator has a few controllable weather factors. These will now be described.

Clouds

Two layers of clouds are simulated. These layers can be turned on and off using the editor system. The bottom and top altitudes of these two solid cloud layers must be set. Setting the top and bottom to an altitude of zero feet turns the layer off. Both cloud layers may be turned on simultaneously. An altitude gap must exist between the layers. This makes it possible to fly between layers of clouds.

Surface Wind

The wind at airport elevation can be set using the editor system. Wind direction and speed must be specified. Wind speed is limited to 100 knots.

Winds Aloft

Winds at three user-defined altitude ranges (above ground level) are adjustable using the editor system. Wind direction and speed must be specified. Wind speed is limited to 99 knots.

Turbulence

A turbulence factor of from 0 to 9 can be added to winds at any wind level. Simply multiply the turbulence factor by 100 and add it to the wind speed. For example, to set a wind speed of 37 knots and turbulence factor 4, set the wind speed to 437 using the editor system.

Turbulence value	Effect
0	no turbulence
1-4	light turbulence
5-6	moderate turbulence
7-9	severe turbulence

Note: Odd turbulence values include up and downdrafts. Even turbulence values just "bounce you around."

Advanced Flight Techniques

There are a few maneuvers and advanced maneuvers that you can perform in coordinated flight, and even more that can be done in uncoordinated flight. A few of these maneuvers now will be examined.

Maneuvers and Advanced Maneuvers

Maneuvers fall into two broad categories: those that make severe demands on the aircraft and put it into unusual attitudes (such as barrel rolls, spins, and loops), and those that use normal flight attitudes but require skill, thought and precision (such as flying a rectangular course in a wind, turns about a point, and eights along a road or around pylons in a wind). Both types of maneuvers are fun, challenging, and help build skills that are useful in everyday and emergency situations.

The FS2 is capable of most maneuvers and advanced maneuvers. There are enough ground reference points to perform ground-reference maneuvers, and the simulated aircraft has the power and airframe strength to do maximum performance flight maneuvers. The editor can be used to set the wind speed and direction to any velocity and angle thereby adding challenge to ground reference maneuvers. The view selector can be used to view the ground reference points while making turns, but when using this feature, make sure to remember which view direction is selected, and always revert to the front view before going on to other flight tasks.

A good student flight manual such as the *Flight Training Handbook*, publication AC 61-21A (1980 revision) put out by the Federal Aviation Administration can be consulted for details on how to perform the following maneuvers:

1. Turns in the wind.
2. "S" turns across a road.
3. Turns around a point.
4. Eights along and across a road.
5. Eights around and on pylons.
6. Line of sight to pylons.

These maneuvers can be performed satisfactorily in auto-coordinated mode as well as coordinated mode.

Many stalls can also be performed in both flight modes.

Uncoordinated Flight

The editor can be used to disable auto-coordinated flight and make the ailerons and rudder work independently. With auto-coordination disabled it is up to the pilot to coordinate turns using the slip/skid indicator. If you are a pilot, your training has included slip and skid procedures, turn coordination methods and warnings that tell you the dangers of uncoordinated flight attitudes. No further explanations are needed. New pilots, however, may wonder why anyone would ever want to fly without auto-coordination (which is available in partial form on some modern aircraft, and even some older models such as the Wright brothers' aircraft). A few good uses for uncoordinated flight will now be presented.

As stated earlier, an aircraft is in coordinated flight when its longitudinal axis is parallel to the direction of flight through the air surrounding it. Coordinated flight is the safest flight attitude. The aircraft is usually in its best aerodynamic position when flying in a coordinated attitude – flying relatively straight through the air (as opposed to flying through air sideways or slightly sideways with air battering one side of the aircraft leaving one wing in an airflow shadow).

Airplanes turn by banking that occurs when you apply ailerons. While in a bank, your wing's lifting force (which normally points straight up in straight flight) points at the bank angle. Some of the force is distributed in the upward direction as usual, but the remaining force (or component of the vector) points sideways. It's this side force that causes the aircraft to start its turn, or at least to start moving slightly sideways through the air. Incidentally, the lifting force is reduced in the bank (some of the vector results in side-force) and this is why the aircraft tends to lose altitude in a bank.

Once the aircraft starts flying slightly sideways, it is in uncoordinated flight. This is where the rudder comes in. The rudder is used to yaw the plane (cause it to rotate about its vertical axis, from side to side). If the plane is flying slightly sideways due to its bank angle, the rudder can be used to straighten the plane out again relative to the sideways oncoming wind. When rudder is applied, the flight becomes coordinated again as the aircraft is yawed. The yaw results in a change in heading. The aircraft turns.

Rudder and aileron are applied together when entering the turn to keep the plane in coordinated flight. The slip/skid indicator ball remains centered to

indicate that the aircraft is coordinated. If the ball is to the right of center, more right rudder is needed. Similarly, when the ball is to the left of center, more left rudder is needed.

A plane that has too little rudder applied flies through the air slightly sideways. This is known as a *slip*. If aileron only is applied, a slip results. With the rudder straight and only aileron applied, the aircraft will still turn. Airplanes have good aerodynamics and like to point into the wind, so the plane will "weather-vane" its way around to a new heading to align itself with the flight path and oncoming wind. The result is an uncoordinated turn. There are no good reasons for performing uncoordinated turns and it's a bad habit to get into.

A bit of REVERSE rudder can be applied in a slip to keep the plane from weather-vaning around. This is where a slip begins to become useful. If right aileron and left rudder are applied, the aircraft banks to the right and thus starts moving to the right. The reverse rudder keeps the plane from yawing to a new heading so the plane's body stays lined-up with a straight flight path. This technique can be used to move the plane to the left or right without changing heading. If you happen to be on final approach and are 30 feet from the runway's center, a slight slip can be entered to move you over 30 feet while your plane remains pointing in the runway's direction.

Slips become even more useful when performing crosswind landings. As mentioned earlier, you must land with your airplane pointing straight down the runway. If you land at a slight angle (in a "crab") your wheels will try to throw the plane off the runway. When landing in a crosswind, however, you must fly at a slight crab angle to compensate for the crosswind and keep you from drifting away from the runway. There are three ways to land in a crosswind. You can make your approach with a crab angle and at the last instant before you touch down "kick it out" of the crab angle. This can be quite dangerous and requires considerable skill to do correctly. The second way is to land on glare ice in a crab angle. Your wheels will simply slide down the runway sideways (hardly a practical solution, but known to work). The practical solution which is most commonly used is to use the slip. The aircraft can be kept aligned with (parallel to) the runway using rudder, and ailerons can be used to increase bank to the point where the airplane is flying sideways at just the right rate to compensate for the crosswind. The

slip can be held all the way down to the landing. This, of course, means you will land in a bank on one wheel. There is nothing wrong with that. Landing on one wheel is part of the crosswind landing technique.

It is important to realize that slips, and any uncoordinated flight, puts extra drag on the aircraft. You will lose altitude faster in a slip than in straight, coordinated flight. This can be put to good use, again on final approach. When you are too high on final approach, a slip can be used to lose some altitude. This practice is used very seldom on modern aircraft, but was used extensively on older planes, especially those without flaps. A slip used to move the plane sideways as in a crosswind landing is known as a *side slip* while a slip used to dissipate altitude without increasing airspeed is a *forward slip*.

Slips, like any uncoordinated flight, put the aircraft in a bad aerodynamic configuration and can thus be dangerous. It's good to get a feel for what the aircraft is capable of by practicing *crossed control stalls* at high altitudes. In this maneuver, you intentionally enter a severe slip or skid until the plane stalls.

When more aileron than rudder is used, a slip results. When more rudder than aileron is used, a *skid* is produced. Skids are of little use and are quite dangerous because they tend to cause the inner wing to stall thereby putting you into a spin or spiral in the direction of your current bank. Severe slips can also stall a wing but they tend to bank you in the opposite direction which tends to correct the problem. A skid immediately increases the problem and can roll you so fast that the bank may be vertical or past vertical before it can be stopped.

Instrument Flight

The FS2 simulator has enough instrumentation, and the "world" has enough VORs, airports, ILS systems, marker beacons, and NDBs to practice IFR flight and approaches. Instruments include two NAV radios and VOR indicators, glide-slope indicator, ADF receiver and bearing indicator, DME, and inner marker, middle marker, and outer marker lights.

The subject of instrument approach techniques is outside the scope of this manual. If you are not an instrument-rated pilot, details of instrument approaches and flying can be found in training manuals such as *Instrument*

Flying by Richard L. Taylor (Macmillan Publishing Co., Inc. 1978). The FS2 Flight Simulator is a good aid in getting familiar with instrument approaches and nicely supplements a training manual.

Instrument approaches are available at many of the 80 airports. Approach information that includes approach-in-use, localizer frequency, and other relevant items can be heard by tuning-in ATIS on the COM radio (ATIS frequencies appear on the charts). This information scrolls across the screen above the 3D display at a rate that can be set using the editor. The ATIS information is a combination of information that would normally be given by ATIS, approach control, tower, and approach plates. If no ATIS is available at the airport, tune in the indicated common traffic advisory frequency.

Instrument approach aids (ILS, beacons, etc.) are patterned after approaches found in *United States Government Instrument Approach Procedures* (standard approach plates). These approach plates can aid you in practicing approaches.

Only a few ILS approaches are included in the supplied airports. See the area charts and any update sheets to determine which approaches are available. Also, check ATIS at the desired airport to determine available ILS and frequency.

More extensive instrument approaches are provided on individual scenery disks.

Playing "World War I Ace"

WW I Ace is a 3D aerial battle game that involves bombing runs and dog-fights with the computer-controlled enemy. Figure 18 shows the battle area and its features.

Starting the Game

To start the game, first go into the editor and set the variable EUROPE 1917 to one. This switches to the battle field shown in Fig. 18. Reenter the flight mode (hit ESC). You will be sitting on the runway of airbase 2. You are fueled, armed, and ready to go. A truce is in effect and hostilities won't begin until you declare war by pressing the W key. You can therefore go on a scouting mission to look over the enemy's territory. You needn't be at your airbase to declare war, and may find it more strategic to be elsewhere when doing so.

Goal

The enemy occupies the territory west of the river. They have established two airbases, a fuel depot for each, and a few factories. Your commander has instructed you to bomb the fuel depots and factories.

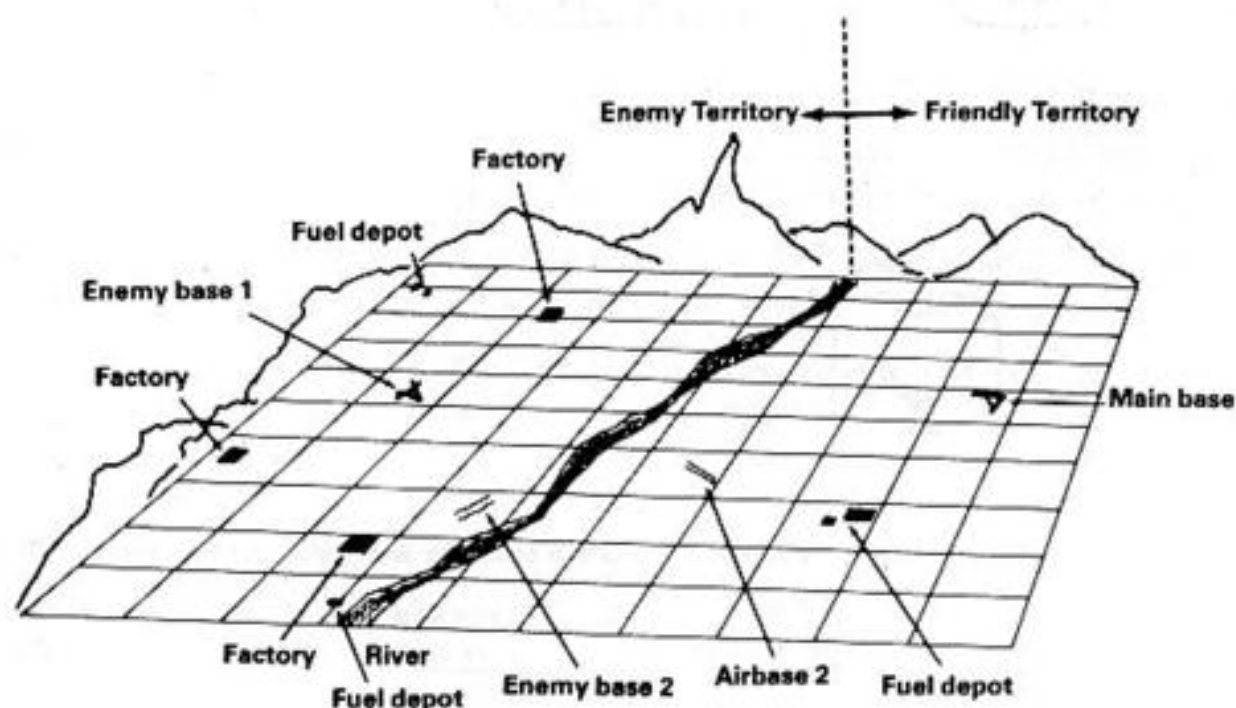
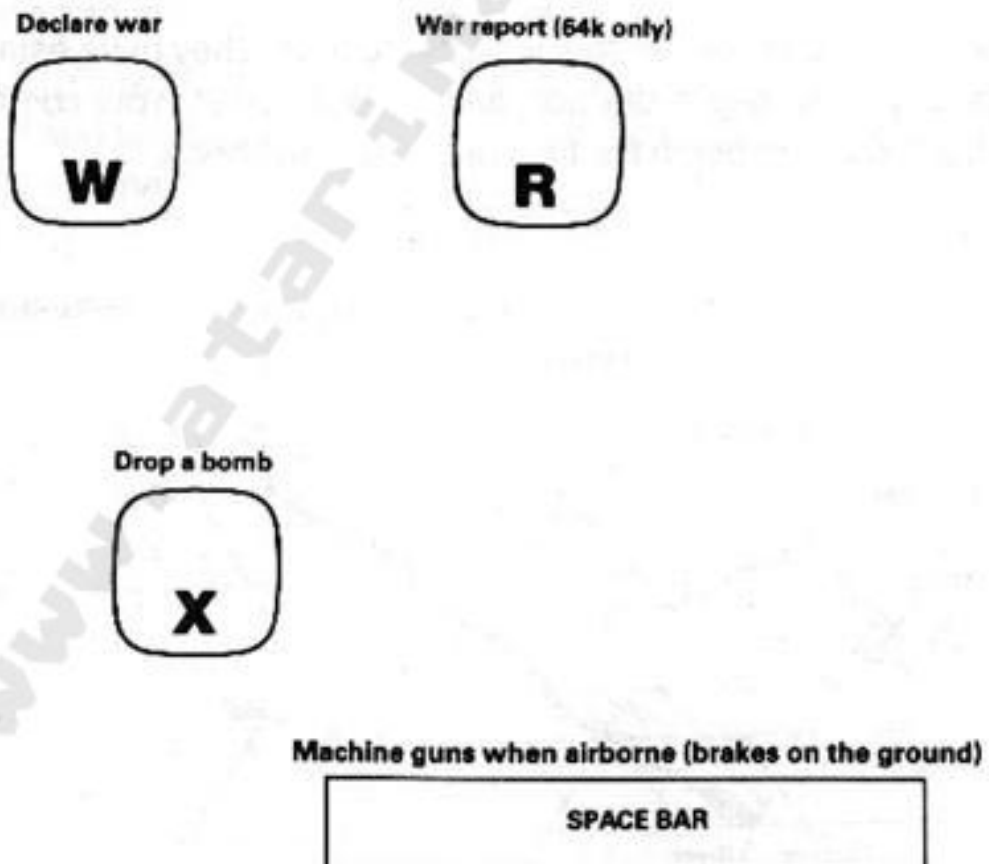

Figure 18: WW I Ace Battleground

Your mission, however, is complicated by six enemy fighters stationed at the airbases. These fighters will protect the fuel depots and factories. Your mission is to shoot down as many enemy fighters as possible and bomb the targets.

Fighting the Fighters

The basic way of fighting a fighter is to get close to one, point straight at it, and fire your machine guns. Figure 19 shows your armament controls. The SPACE BAR is the gun trigger and rapid bursts of many shots are needed to be effective. You have a probabilistic chance of hitting an enemy if he is within your gun's sights and range, but the distance you must be from the enemy decreases rapidly as the enemy moves to the sides of the sights. The guns have good straight range, but poor side range.



Note: Joystick push buttons also fire machine guns when in the air.

Figure 19. WW I Ace Armament Controls

Every enemy fighter has a different flying technique. The enemy pilots have orders to intercept any invader, but each fighter pilot has different instructions concerning when to launch and when to return back to base. The pilots are of different skill levels. Some take a long time to successfully hit you, while the Aces are very proficient and score quickly.

Fighter planes as well as pilots are different from one another. There are two fast, rugged, fighters with unreliable guns, one plane with good speed and maneuverability, one reliable fighter with average speed, maneuverability and guns, and two super fighters. These planes all have different climb rates and cruise performance. Count on the Aces to be in the best planes.

Fighter Mode Instrumentation

The instrument panel is augmented with fighter aircraft instrumentation when playing WW I Ace. The *multipurpose instrument panel area* (the radio stack area) goes into its attack radar mode. In this mode, a small airplane outline appears at the screen's center and the position of enemy fighters around you is shown. The upper line of the attack radar screen flashes status messages indicating important war events.

Using Radar

World War I aircraft had no radar, but the FS2 does. This radar is available to compensate for viewing restrictions of the 3D screen. The radar picks up enemies around you. The small plane in the center of the radar represents your position and orientation, and enemy aircraft are represented by dots on the screen. This radar has approximately a 1-mile radius range.

This is a 3D radar system. Aircraft dots are color-coded to indicate their altitude:

Color	Meaning
Orange	Enemy below you
White	Enemy within 100 feet of your altitude
Blue	Enemy above you

Bombing

The fuel depots and factories are the targets. There is only one load of five bombs so you can destroy a maximum of five targets per mission. Refueling at base 1 automatically reloads new bombs. Base 2 only has fuel.

The downward view includes a bomb sight in war mode. This is used to aim at the target. The X key drops a single bomb.

Getting Shot Down

The enemy can shoot you down. Every hit that the enemy gets degrades the performance of your aircraft. Note that a shooting enemy doesn't necessarily score. Hits depend on the enemy pilot's skill level. If your aircraft is damaged (acting strangely, losing fuel, or oil pressure dropping), try to make it back to the base for repairs and refueling.

Becoming an Ace

You must down at least five enemy aircraft to become an Ace. Extra points will bring you other honors. Points are issued as follows:

Points	Action
1	Downing an enemy aircraft (depending on aircraft and damage inflicted).
20	Bombing a factory.
10	Destroying a fuel depot.

There are only 6 enemy fighters spread between the two enemy airbases. Enemy aircraft are replaced while you are at your base.

Appendix 1 Aircraft Specifications

The FS2 is designed to simulate the performance characteristics of a Piper Cherokee Archer II PA-28-181.

Aircraft Profile and Dimensions:

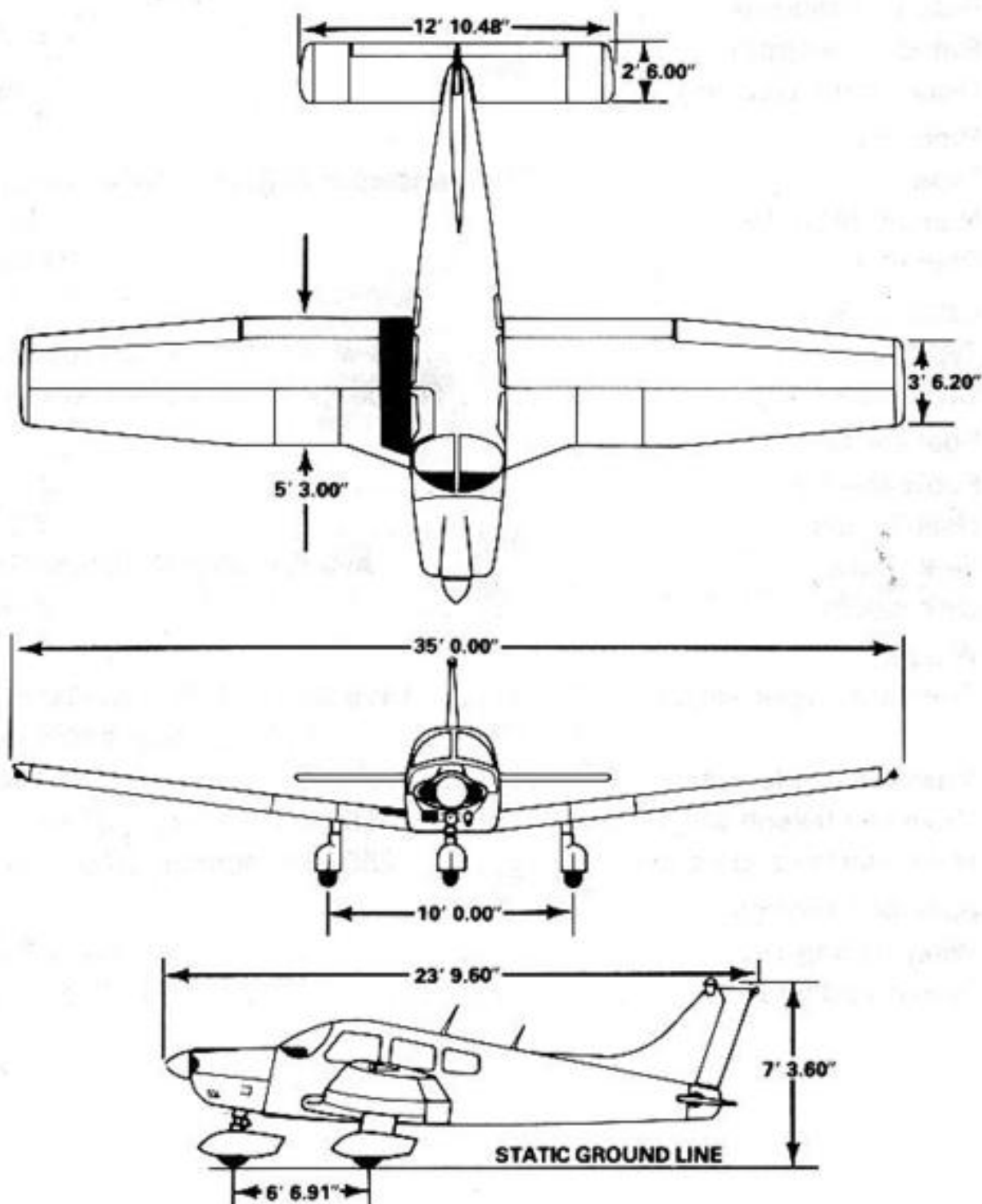

Additional Dimensions

Wing area 170 sq. ft.
Minimum turning radius 30 ft.

Engine

Type Single engine Lycoming O-360-A4A four-cylinder,
direct-drive, horizontally opposed, air cooled

Rated horsepower 180

Rated speed (rpm) 2700

Displacement (cu. in.) 361.0

Propeller

Type One Sensenich 76EM8S5-0-62, fixed pitch

Number of blades 2

Diameter 76 inches

Landing Gear

Type 3-wheel tricycle, non-retractable

Ground steering Rudder pedal controlled nose wheel

Fuel and Oil

Fuel capacity 50 U.S. gal.

Usable Fuel 48 U.S. gal.

Fuel Grade Aviation 100/130 octane Green

Oil capacity 8 quarts

Weights

Standard empty weight 1416 lbs. (including unusable fuel,
full operating fluids and oil)

Maximum useful load 1134 lbs.

Maximum takeoff weight 2550 lbs. normal, 2130 lbs. utility

Maximum landing weight 2550 lbs. normal, 2130 lbs. utility

Specific Loadings

Wing loading 15.0 lbs. per sq. ft.

Power loading 14.2 lbs. per hp

Appendix 2 Aircraft Characteristics

Airspeed Limitations	KIAS (indicated airspeed in knots)	KCAS (calibrated airspeed in knots)
Never exceed speed Vne Do not exceed in any operation.	154	148
Maximum structural cruising speed Vno Do not exceed this speed except in smooth air; then only with caution.	125	121
Design maneuvering speed Va @2550 lbs.	113	111
@1634 lbs.	89	89
Do not make full or abrupt control movements above this speed.		
Maximum flaps extended speed Vfe Do not exceed this speed with flaps extended.	102	100
Flight Load Factors		
Positive load factor maximum	3.8G normal	4.4G utility
Negative load factor maximum	No inverted maneuvers approved	
Airspeeds for Safe Operation		
Best rate of climb speed	76 KIAS	
Best angle of climb speed	64 KIAS	
Turbulent air operating speed	113 KIAS	
Maximum flap speed	102 KIAS	
Landing final approach speed (flaps 40 degrees)	66 KIAS	
Maximum demonstrated crosswind velocity		17 KTS

General Performance

Max rate of climb @sea level	735 fpm
Service ceiling	13,650 ft.
Cruise, 75% power @8000 ft	129 kts.
Range at 55% power, 45 min reserve ..	670 nm
Stall speed (at G.W., power off, full flaps)	49 KIAS

www.atariomania.com

Appendix 3

48K and 64K Feature Comparison

Flight Simulator II is a large program that runs with program segment and map database disk overlays. The simulator's central core and overlay area are too large to fit in a 48K memory space, so a core with less features and performance is provided for 48K machines. The Flight Simulator II disk comes with both core segments. The presence of 64K is detected automatically on simulator startup, and the proper core is loaded from disk.

Note to 48K user: Please read this list to know what to expect when running FS2.

64K only features:

1. ADF
2. Reality effects
3. Wingtip generation
4. Bomb sight
5. War report
6. COM radio
7. Instrument panel lights ON/OFF switch
8. Course plotter

Appendix 4 Program Specifications

The Design Team:

- Bruce Artwick** Concepts, system design, simulation, graphics drivers, control panel design, disk overlay structures, documentation, database design, editor system.
- David Denhart** "Unidisk" Disk I/O system, war game implementation, sound system, custom Atari features.
- Charles Guy** Graphics drivers, gauge movements, database design.
- Stu Moment** Database design, documentation, aeronautical advice.
- Mike Woodley** Scenery disk implementation.

Production Coordination was by Norm Olsen and Bob Chapdu.

Program Size:	Core System	32K
	Screen Memory	16K (8K x 2 double buffered)
	Extended Core	16K

Projection Rate: 2 to 6 frames/second.

Language: 6502 assembly language.

Internal Mathematics: 8, 16, and 32-bit integer.

System Structure: 8-way time-sliced executive with software-emulated real-time interrupt system.

Development System: SubLOGIC 8088/Z80 DEVELOPMENT SYSTEM 1 using a CDL 6502X macro assembler with SubLOGIC's preamble, SubLOGIC Unipix graphics editor, Unibug 2 debugger, and Unimap map designer.

Developed: November 1983 to June 1984 at SubLOGIC Corporation's labs in Champaign, Illinois. Large portions of this program were derived from SubLOGIC's AT-3DZ graphics package, AT-FS1 flight simulator, IB-FS1 flight simulator driver (also used in Microsoft Flight Simulator), and AT-PB1 pinball.

We constantly improve our flight simulation products and appreciate feedback regarding flight performance, scenery, and bugs. Our top priority at the moment is building up a large collection of scenery disks. Sectional, terminal area, and world air charts are used for overall design, and aerial photographs (many from postcards) are used to construct landmark buildings and city scenery. If you have any short comments regarding the flight simulator, please send them on a picture postcard of your area (preferably one with an aerial view).

www.atari.mani

Appendix 5
Interesting Topographical Features

See enclosed sheet for current listing of topographic details.

Index

- ADF 20,35,48,65
- Aerobatics 70
- Aileron 22,41,71
- Airspeed indicator 13,16
- Altimeter 16,36
- Approach Speed 42
- Artificial horizon 13,16
- ATIS 20
- Attitude indicator 13,16
- Ball gauge 13
- Bank 22,24
- Beacons (airport) 63
- Beacons (marker) 19
- Bombing 76,78
- Booting 11
- Boot (reboot) 36
- Boston 54
- Brakes 32
- Carb heat 19,33
- Check list 39
- Champaign 54
- Chicago 54
- Climbing 40
- Clock 18,68
- Clouds 47,69
- Compass (gyro), see heading indicator
- Compass (magnetic) 18
- Control keypresses 23,24,25,27,28, 30,31,55
- Control key 10
- Course plotting 66
- COM radio 19,29,34
- Controls 21
- Control yoke 21,23
- Control stick 21
- Coordinates 46
- Coordination 41,71
- Copying modes 50
- Custom modes 44
- Crab angle 72
- Crashing 12
- Dawn 68
- Demo flight 11
- Dihedral effects 42
- Disk mode save 51
- Dives 41
- DME 20,63
- Dog fights 76
- Dusk 68
- Editor system 44,53
- Elevator trim 32
- Elevators 25,26,40,41
- Engine controls 33
- Engine gauges 19
- Environmental effects 68
- FAA requirements 9,13
- Flaps 29,32,41
- Flight training 9
- Floppy disk 10
- 48K features 10,83
- Fuel tank selector 33
- Fuel management 33
- Game 75
- Glides 41
- Glide slope 18
- Gauges 19
- Guns 76
- Heading indicator 13,36
- IFR 13,37,73
- ILS 74
- Instrument flight 73
- Instrument panel 14
- Joystick 10,26,48
- Joystick calibration 26
- Landing 42
- Level flight 40
- Lights 18,29,36
- Loops 70
- Los Angeles 54
- Magnetos 18,33
- Maneuvers 70
- Manuals 9
- Maps 9

- Marker beacons 19
- Micro-adjustable elevators 26
- Mixture control 33
- Modes 48
- Mode load/save 51
- Navigation 54
- NAV radio 19,29,34
- New York 54
- Omni-bearing indicator 18,35
- Pause 36
- Pitch 22,25
- Plotting 66
- Preset modes 50
- Program specifications 84
- Radios 19,29,34
- Radar 35,77
- RAM-card 10
- Reality effects 45
- Reboot 36
- Reference card 30,31
- Refueling 43
- Regulations 9
- Reliability 48
- Repeat Key 36
- Reset 36
- Rolls 70
- Rudder 23,26,41,71
- Rudder pedals 23,26
- Running the program 10
- Runway numbers 37
- Saving modes to disk 51
- Scenery Disk 11
- Score 78
- Scroll rate (communications) 46
- Seasons 47,68
- Seattle 54
- 64K features 10,83
- Skids 73
- Slip/skid indicator, see turn coordinator
- Slew 45,54,55
- Slips 72
- Sound 45
- Specifications 79
- Speeds 81
- Spins 70
- Stalls 70
- Sunrise 68
- Sunset 68
- Surface winds 69
- System requirements 10
- Taxiing 38
- Takeoff 39
- 3D display 13
- Throttle 23,28,41,42
- Time 47,68
- Transponder 29,35
- Turbulence 69
- Turn coordinator 13,17
- Turns 41
- Tutorial 11,37
- Uncoordinated flight 71
- User mode library 48
- VFR 13,37
- Vertical speed indicator 13,18
- View selector 13,35
- VOR 29,35,56-63
- War game 46,75
- Weather 69
- Wind 47
- Wind (magnetic vs true) 48
- Winds aloft 69
- World War I ace 78
- Xpnder, see transponder
- Yaw 22,27
- Yoke 21,23

SubLOGIC Media Policy

SubLOGIC Corporation warrants all media for a period of 6 months from the date of purchase. We will replace any media that are out of warranty at a minimal charge.* SubLOGIC will extend this replacement service for a period of not less than 10 years after purchase.

If you wish to return defective cassettes or disks, please return ***the media only***.

We have established an efficient and very fast repair/replacement system which promises long run benefits to you. Returning the manuals will complicate the system and will raise shipping costs.

*Example: replacement charges on October 1, 1983, \$5.00 for a disk – \$4.00 for a cassette.

About the Author

Bruce Artwick has been designing microcomputer software since 1977. His first **Flight Simulator** program for the Apple II was released in 1979 at a time when the typical system configuration for that machine consisted of 16K memory, Integer BASIC, 3-color hi-res graphics, and a cassette program loader. Working within these limitations, **Flight Simulator** was (and remains) a classic in both design and execution, a program that set the standard for all that was to follow.

Some of the 3D animation routines Bruce used in the development of **Flight Simulator** later found their way into his **A2-3D1 Graphics Package**, a collection of programs for the creation and manipulation of 3D images. An enhanced **A2-3D2** version came out in 1981 to take advantage of the Apple II plus's increased capabilities.

Bruce's reputation as a master of microcomputer simulation grew with the release of **Night Mission Pinball** in 1982. A programming tour de force that recreates the look and feel of a real pinball table down to the finest detail, **Night Mission** offers ten different play modes, each completely user-adjustable. The game's theme is based on a WWII night bombing run.

Flight Simulator II, Bruce's newest creation, once again sets new standards in sophistication for a new generation of microcomputers. The program graphically places you in the pilot's seat of a modern single-engine aircraft with complete instrumentation and full color out-the-window view.

subLOGIC

Corporation

713 Edgebrook Drive

Champaign IL 61820

(217) 359-8482 Telex: 206995